

2754P SPECTRUM ANALYZER

Valuetronics International, Inc.
1-800-552-8258
MASTER COPY

Please Check for CHANGE INFORMATION at the Rear of This Manual

First Printing JUN 1986
Revised MAR 1987

Tektronix[®]
COMMITTED TO EXCELLENCE

Copyright © 1986 Tektronix, Inc. All rights reserved.
Contents of this publication may not be reproduced in
any form without the written permission of Tektronix, Inc.

Products of Tektronix, Inc. and its subsidiaries are
covered by U.S. and foreign patents and/or pending
patents.

TEKTRONIX, TEK, SCOPE-MOBILE, and  are
registered trademarks of Tektronix, Inc. TELEQUIP-
MENT is a registered trademark of Tektronix U.K.
Limited.

Printed in U.S.A. Specification and price change
privileges are reserved.

Tektronix, Inc.
P.O. Box 500
Beaverton, Oregon 97077

Serial Number

PREFACE

This manual is one of a set of product manuals for the TEKTRONIX 2754P Programmable Spectrum Analyzer. This manual describes the programmable functions of the spectrum analyzer and how to use them for remote operation. The manual organization is shown in the Table of Contents. The manuals that are available now in addition to this Programmers Manual are the

- 2754/2754P Operators Manual (standard accessory),
- 2754/2754P Service Manuals, Volume 1 and 2 (standard accessories),
- 2750P-Series Programmers Reference Guide (optional accessory).

For manual ordering information, contact your local Tektronix Field Office or representative or refer to the Accessories portion of the Replaceable Mechanical Parts list in the Service Manual, Volume 2.

Standards and Conventions Used

Most terminology is consistent with standards adapted by IEEE and IEC. A glossary of terms is provided in Appendix A. Abbreviations in the documentation are consistent with ANSI Y1.1-1972. GPIB functions conform to the IEEE 488-1978 Standard and the Tektronix Interface Standard for GPIB Codes, Formats, Conventions, and Features. Copies of ANSI and IEEE standards can be ordered from the Institute of Electrical and Electronic Engineers Inc. Contact your local Tektronix Field Office or representative if you have questions regarding the Tektronix reference document.

Change/History Information

Any change information that involves manual corrections or additional information is located behind the tabbed Change Information page at the back of this manual.

History information, as well as the updated data, is combined within this manual when the page(s) is revised. A revised page is identified by a revision date located in the lower inside corner of the page.

Unpacking and Initial Inspection

Instructions for unpacking and preparing the instrument for use are described in Section 3 of the Operators Manual.

Storage and Repackaging

Instructions for short- and long-term storage and instrument repackaging for shipment are described in Section 3 of the Operators Manual.

TABLE OF CONTENTS

	Page		Page
PREFACE.....	i	Section 3	DEVICE-DEPENDENT MESSAGE STRUCTURE AND EXECUTION
TABLE OF CONTENTS.....	ii	Syntax Diagrams.....	3-1
LIST OF ILLUSTRATIONS.....	v	Spectrum Analyzer Input Messages.....	3-1
LIST OF TABLES.....	v	Input Message Format.....	3-1
SAFETY SUMMARY.....	vi	Message Unit Delimiter (;).....	3-2
Section 1	INTRODUCTION TO GPIB OPERATION	Message Terminator (TERM).....	3-2
GPIB Pushbutton and Indicators.....	1-1	Format Characters.....	3-2
RESET TO LOCAL/REMOTE.....	1-1	Input Buffering and Execution.....	3-2
<SHIFT> PLOT.....	1-1	Command Format.....	3-2
<SHIFT> SRQ.....	1-1	Header.....	3-2
ADDRESSED.....	1-1	Header Delimiter (SP).....	3-2
GPIB Function Readout.....	1-1	Argument Delimiter (,).....	3-2
Setting the GPIB ADDRESS Switches.....	1-2	Argument Format.....	3-3
Setting the LF OR EOI Switch.....	1-3	Numbers.....	3-3
Setting the TALK ONLY and LISTEN ONLY Switches.....	1-3	Units.....	3-3
IEEE 488 Functions.....	1-4	Character Argument.....	3-3
Source Handshake (SH1).....	1-4	Link Argument.....	3-3
Acceptor Handshake (AH1).....	1-4	String Argument.....	3-3
Talker (T5).....	1-4	Query Format.....	3-4
Listener (L3).....	1-4	Query Response Format.....	3-4
Service Request (SR1).....	1-5	Binary Block.....	3-4
Remote/Local (RL1).....	1-5	End Block.....	3-4
Parallel Poll (PP1).....	1-5	Spectrum Analyzer Output Messages.....	3-4
Device Clear (DC1).....	1-5	Output Message Format.....	3-4
Device Trigger (DT1).....	1-5	Output Message Execution.....	3-4
Controller (C0).....	1-5	490P-490AP/2750 Series Compatibility...3-4	
Connecting to a System.....	1-5	GPIB.....	3-5
Section 2	GETTING STARTED	DEGAUS Command.....	3-5
Setting and Querying		IDENT Command.....	3-5
Programmable Controls.....	2-1	PEAK Command.....	3-5
Setting Programmable Controls.....	2-1	Readout Maximum.....	3-5
Querying Programmable Controls.....	2-2	Service Requests.....	3-5
Exercise Routines.....	2-3	Affect of Busy on Device- Dependent Messages.....	3-5
Talk/Listen.....	2-3	GET (Group Execute Trigger).....	3-5
Acquiring Instrument Settings with the SET Query.....	2-3	EVENT?/ERR? Codes.....	3-5
Resetting the Spectrum Analyzer and Interface Messages.....	2-4	Preserving Frequencies.....	3-6
Acquiring a Waveform.....	2-4	MINATT Command.....	3-6
Getting Smarter.....	2-4	Reference Level.....	3-6
Getting Smarter Another Way.....	2-5	RDOUT Command.....	3-6
		Section 4	INSTRUMENT CONTROL
		Frequency.....	4-3
		FREQ.....	4-3
		TUNE.....	4-4
		TMODE.....	4-4
		FIRST.....	4-5
		SECOND.....	4-5
		DISCOR.....	4-5
		FRQRNG.....	4-6
		STEP.....	4-6
		MSTEP.....	4-7

	Page		Page
Section 4 (continued)		Section 5 MARKER SYSTEM	
PSTEP.....	4-7	Waveform Finding.....	5-1
STSTOP.....	4-7	System Control.....	5-1
DELFR.....	4-8	MARKER.....	5-1
DEGAUS.....	4-8	MTRACE.....	5-2
IMPED.....	4-8	NSELVL.....	5-3
Frequency Span and Resolution.....	4-10	SGTRAK.....	5-3
SPAN.....	4-10	Marker Positioning.....	5-4
ZEROSP.....	4-11	DPMK.....	5-4
MXSPN.....	4-12	MAMPL?.....	5-4
RESBW.....	4-12	MCEN.....	5-5
ARES.....	4-13	MCPOIN.....	5-5
IDENT.....	4-13	MEXCHG.....	5-5
Vertical Display and Reference Level....	4-15	MFREQ.....	5-5
VRTDSP.....	4-16	MKDP.....	5-6
REFLVL.....	4-16	MLOCAT?.....	5-6
RLUNIT.....	4-17	MTOP.....	5-7
CAL.....	4-18	MTUNE.....	5-7
ENCAL.....	4-19	Marker Finding.....	5-7
FINE.....	4-20	HRAMPL.....	5-7
RLMODE.....	4-20	LRAMPL.....	5-8
PEAK.....	4-21	BWNUM.....	5-8
MINATT.....	4-21	BWMODE.....	5-8
MAXPWR.....	4-22	MFBIG.....	5-9
RFATT?.....	4-22	MLFTNX.....	5-9
PLSTR.....	4-23	PKFIND.....	5-10
VIDFLT.....	4-23	MMAX.....	5-10
Sweep Control.....	4-24	MMIN.....	5-11
TRIG.....	4-24	MRGTNX.....	5-11
SIGSWP.....	4-25	THRHL.....	5-12
TIME.....	4-26	MVLADB.....	5-12
Digital Storage.....	4-27	MVRTDB.....	5-13
AVIEW.....	4-27	STYPE.....	5-13
BVIEW.....	4-28	SGERR.....	5-17
SAVEA.....	4-28	Miscellaneous.....	5-18
BMINA.....	4-29	ZOOM.....	5-18
DSTORE.....	4-29		
DRECAL.....	4-29	Section 6 DISPLAY DATA AND CRT READOUT I/O	
MXHLD.....	4-30	Waveform Transfers.....	6-1
CRSOR.....	4-30	WFMPRE.....	6-1
Display Control.....	4-32	CURVE.....	6-3
REDOUT.....	4-32	WAVFRM.....	6-4
GRAT.....	4-33	DPRE?.....	6-4
CLIP.....	4-33	DCOPY?.....	6-5
General Purpose.....	4-34	Crt Readout Transfers.....	6-5
HDR.....	4-34	RDOUT.....	6-5
STORE.....	4-35	TEXT.....	6-6
RECALL.....	4-35	UPRDO.....	6-6
PLOT?.....	4-35	MDRDO.....	6-6
PTYPE.....	4-36	LORDO.....	6-7
POFSET.....	4-36		

	Page
Section 7 WAVEFORM PROCESSING	
Waveform Finding	7-1
POINT	7-1
FIBIG.....	7-2
LFTNXT.....	7-2
RGTNXT.....	7-2
FMAX.....	7-2
FMIN	7-2
Data Point Commands Interaction	7-2
CENSIG.....	7-3
TOPSIG.....	7-3
Section 8 SYSTEM COMMANDS AND QUERIES	
Instrument Parameters.....	8-1
SET?	8-1
INIT	8-6
ID?	8-6
HDR	8-7
Message Execution.....	8-7
WAIT.....	8-7
REPEAT	8-7
Status and Error Reporting	8-8
EOS.....	8-8
RQS	8-8
WARMSG.....	8-9
Status Byte	8-9
Effect of Busy on Device- Dependent Messages	8-10
Effect of Busy on Interface Messages.....	8-10
DT	8-11
EVENT?.....	8-11
ALLEV?	8-11
NUMEV.....	8-11
EVQTY?.....	8-12
TEST?	8-12
Error Codes.....	8-13
Section 9 HELPS AND HINTS	
Programming Techniques.....	9-1
Signal Processing	9-1
Data Acquisition	9-1
Synchronizing Controller and Spectrum Analyzer.....	9-1
Synchronizing with the Sweep	9-2
Using the End-of-Sweep SRQ.....	9-2
INPUT: An SRQ Alternative.....	9-4
Binary Waveform Transfer.....	9-4
Getting Spectrum Analyzer Binary Curve Output.....	9-4
Sending a Binary CURVE to the Spectrum Analyzer.....	9-4
Scaling, Saving, and Graphing Waveform Data.....	9-5
Saving the Scaled Array.....	9-5
Storing Settings	9-5
Using PLOT.....	9-5

	Page
Section 9 (continued)	
Multiple Use of Display Buffer.....	9-6
Buffer Data Flow	9-6
Order-Dependent Conflicts.....	9-6
Finding Signals with Waveform Processing	9-7
Understanding How Waveform Processing Works.....	9-7
Setting the Threshold.....	9-8
Acquiring Data for Waveform Processing.....	9-8
Spectrum Search	9-8
Using MCEN.....	9-9
High Center Frequency Drift Rate After Tuning	9-9
Spectrum Search Using Repeat	9-9
Messages on the Crt Using RDOUT.....	9-9
Using CAL Over the Bus	9-10
Comparing FREQ and TUNE	9-10
Comparing the Status Byte and the ERR? Response	9-10
Execution and Transfer Times.....	9-11

Appendix A IEEE STD 488 (GPIB) SYSTEM CONCEPTS	
Mechanical Elements	A-1
Electrical Elements.....	A-1
Functional Elements.....	A-1
A Typical GPIB System.....	A-2
Talkers, Listeners, and Controllers	A-2
Interface Control Messages.....	A-2
Device-Dependent Messages	A-5
GPIB Signal Line Definitions	A-6
Transfer Bus (Handshake).....	A-6
Management Bus.....	A-6
Interface Functions and Messages	A-8
RL (Remote-Local Function)	A-8
T/TE and L/LE (Talker and Listener Functions).....	A-8
SH and AH (Source and Acceptor Handshake Functions)	A-9
DC (Device Clear Function).....	A-9
DT (Device Trigger Function).....	A-9
C, SR, and PP (Controller, Service Request, and Parallel Poll Functions).....	A-10
Taking Control (Asynchronous or Synchronous).....	A-10
Passing Control.....	A-10
Performing a Serial Poll.....	A-10

Appendix B INDEX AND PROGRAMMING FUNCTIONS	
---	--

SAFETY SUMMARY

(Refer all servicing to qualified servicing personnel)

The safety information in this summary is for both operating and servicing personnel. Specific warnings and cautions will be found throughout the manual where they apply, but may not appear in this summary.

CONFORMANCE TO INDUSTRY STANDARDS

The 2754/2754P complies with the following Industry Safety Standards and Regulatory Requirements.

Safety

CSA: Electrical Bulletin

FM: Electrical Utilization Standard Class 3820

ANSI C39.5 — Safety Requirements for Electrical and Electronic Measuring and Controlling Instrumentation.

IEC 348 (2nd edition) — Safety Requirements for Electronic Measuring Apparatus.

Regulatory Requirements

VDE 0871 Class B — Regulations for RFI Suppression of High Frequency Apparatus and Installations.

TERMS

In This Manual

CAUTION statements identify conditions or practices that could result in damage to the equipment or other property.

WARNING statements identify conditions or practices that could result in personal injury or loss of life.

As Marked on Equipment

CAUTION indicates a personal injury hazard not immediately accessible as one reads the marking, or a hazard to property, including the equipment itself.

DANGER indicates a personal injury hazard immediately accessible as one reads the marking.

SYMBOLS

In This Manual



This symbol indicates where applicable cautionary or other information is to be found.

As Marked on Equipment



DANGER — High voltage.



Protective ground (earth) terminal.



ATTENTION — refer to manual.



Refer to manual

POWER

Power Source

This product is intended to operate from a power source that will not apply more than 250 V rms between the supply conductors or between either supply conductor and ground. A protective ground connection by way of the grounding conductor in the power cord is essential for safe operation.

Grounding the Product

This product is grounded through the grounding conductor of the power cord. To avoid electrical shock, plug the power cord into a properly wired receptacle before connecting it to the product input or output terminals. A protective ground connection by way of the grounding conductor in the power cord is essential for safe operation.

Danger From Loss of Ground

Upon loss of the protective-ground connection, all accessible conductive parts (including knobs and controls that may appear to be insulating) can render an electric shock.

Use the Proper Power Cord

Use only the power cord and connector specified for your product.

Use only a power cord that is in good condition.

Refer cord and connector changes to qualified service personnel.

For detailed information on power cords and connectors, see the Maintenance section in the Service Manual, Volume 1.

Use the Proper Fuse

To avoid fire hazard or equipment damage, use only the fuse of correct type, voltage rating, and current rating for your product (as specified in the Replaceable Electrical Parts list in Volume 2 of the Service Manual). Refer fuse replacement to qualified service personnel.

OPERATIONAL PRECAUTIONS

Do Not Operate in Explosive Atmospheres

To avoid explosion, do not operate this product in an explosive atmosphere unless it has been specifically certified for such operation.

Do Not Remove Covers or Panels

To avoid personal injury, do not remove the product covers or panels unless you are qualified to do so. Do not operate the product without the covers and panels properly installed.

Dangerous voltages exist at several points in this product. To avoid personal injury, do not touch exposed connections and components while power is on. REFER ALL SERVICING TO QUALIFIED SERVICE PERSONNEL.

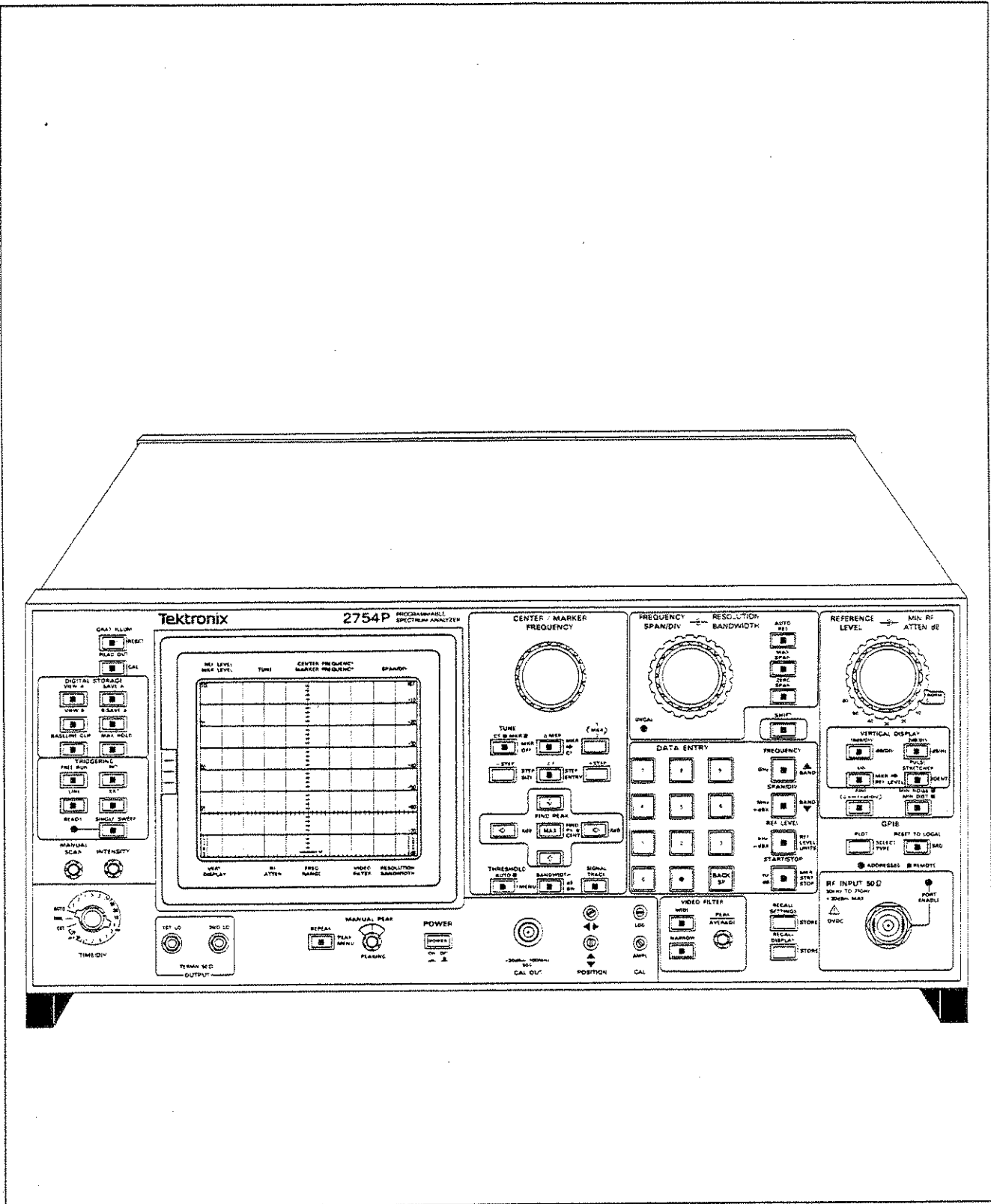

TEKTRONIX 2754P Programmable Spectrum Analyzer

INTRODUCTION TO GPIB OPERATION

The TEKTRONIX 2754P Programmable Spectrum Analyzer adds remote control and automated spectrum data acquisition and analysis to the performance and portability features of the TEKTRONIX 2754 non-programmable Spectrum Analyzer. The programmable spectrum analyzer front panel can be controlled remotely (except for those controls intended for local use only, such as INTENSITY). Waveform processing functions are added to do some spectrum analysis locally.

The IEEE Std 488 General Purpose Interface Bus (GPIB) port in the spectrum analyzer rear panel allows it to be used with a wide variety of systems and controllers; the instrument follows the Tektronix Interface Standard for GPIB Codes, Formats, Conventions, and Features. This standard promotes ease of operation and makes the spectrum analyzer compatible with other Tektronix instruments and, as much as possible, with GPIB instruments from other manufacturers.

GPIB PUSHBUTTON AND INDICATORS

(see Figure 1-1)

RESET TO LOCAL/REMOTE

The REMOTE indicator is lit when the spectrum analyzer is under control of the GPIB controller. While under remote control, the other front-panel controls and pushbuttons are not active; but, indicators will still reflect the current state of all front-panel functions except TIME/DIV, MIN RF ATTEN dB, and PEAK/AVERAGE.

The REMOTE indicator is not lit when the instrument is under local, operator control. While under local control, the instrument does not execute GPIB messages that would conflict with front-panel controls, and it does not change the waveforms in digital storage.

When the instrument is under remote control and RESET TO LOCAL is pressed, local control is restored to the operator unless the controller prevents this with the local lockout message. Programmable functions do not change when switching from remote to local control except as necessary to match the settings of front-panel controls for TIME/DIV, MIN RF ATTEN dB, and PEAK/AVERAGE.

The spectrum analyzer flashes the instrument and firmware version numbers and the GPIB address on the crt when RESET TO LOCAL is pressed.

PLOT

Press this pushbutton when the spectrum analyzer is in the talk-only mode for the instrument to send the appropriate commands over the GPIB to a plotter, which must be in the listen-only mode, connected to the bus (see the TALK ONLY, LISTEN ONLY switch descriptions later in this section). The spectrum analyzer display (waveform, marker(s), graticule, and crt readout) can be recreated on a TEKTRONIX 4662 Option 01 or 4662 Option 31 Interactive Digital Plotter (or a 4663 in the 4662 emulation mode); or a Hewlett-Packard HP7470A or HP7475A, HP7580B, HP7585B, or HP7486B; or a Gould 6310 or 6320 plotter. Select plotter type with <SHIFT> 2, described in Section 4 of this manual. The plotter must be in the listen-only mode. A bus controller is not required.

<SHIFT> SRQ

This pushbutton sequence gets the controller's attention so it will listen/respond to the spectrum analyzer. For example, if the controller put instructions on the screen, in the TEXT LONG mode, to set up test equipment, etc., the last line of the instructions would say "PRESS <SHIFT> SRQ WHEN READY". This would instruct the controller to go on to the next step. An SRQ will only be issued if RQS is on.

ADDRESSED

This indicator is lit when the spectrum analyzer is addressed to listen or talk.

GPIB Function Readout

A single character appears in the lower crt readout when the spectrum analyzer is talking (T), or listening (L); see Figure 1-2. Two characters will appear in this location if the instrument is talking or listening and also requesting service (S), or if the instrument is in both the talk-only and listen-only mode.

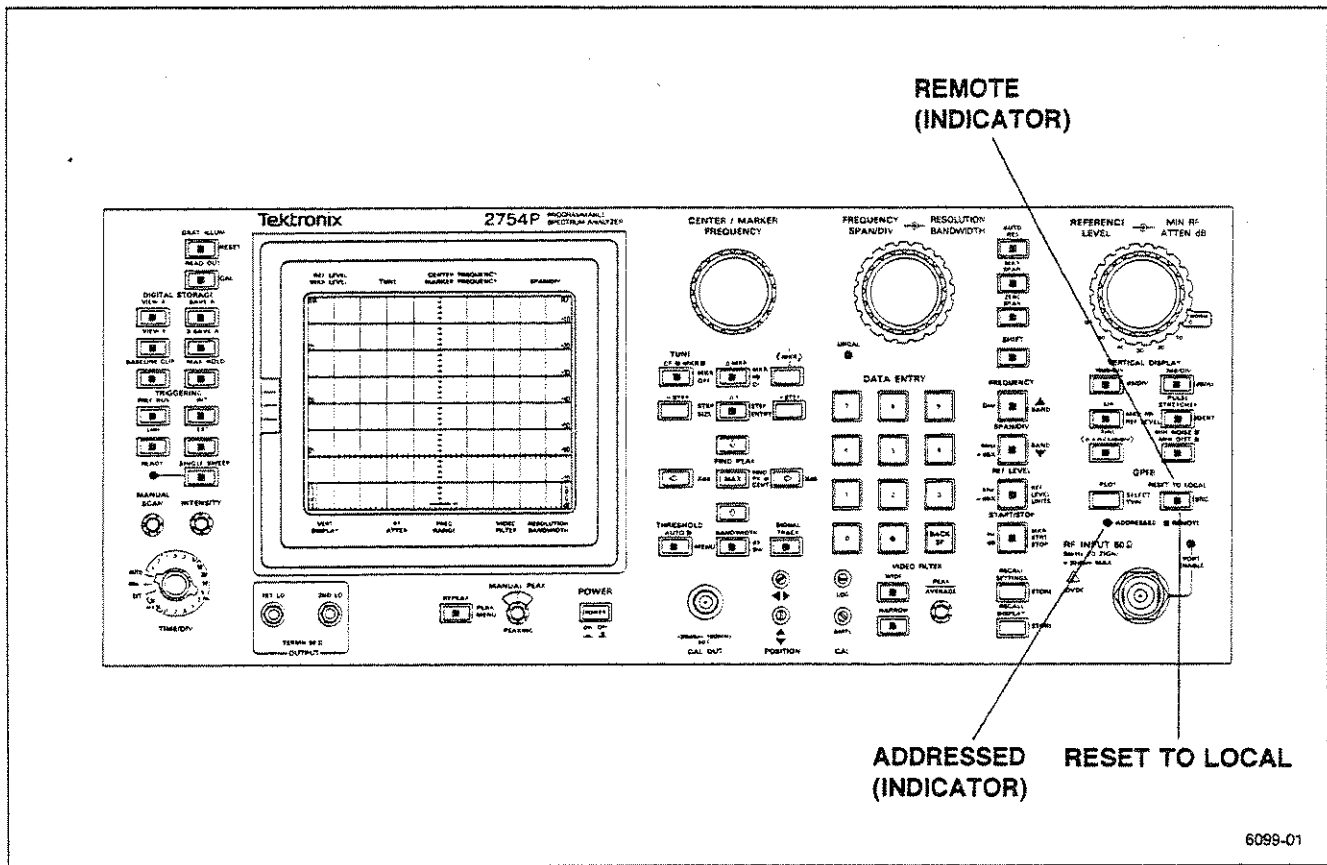

Figure 1-1. GPIB pushbutton and indicators.

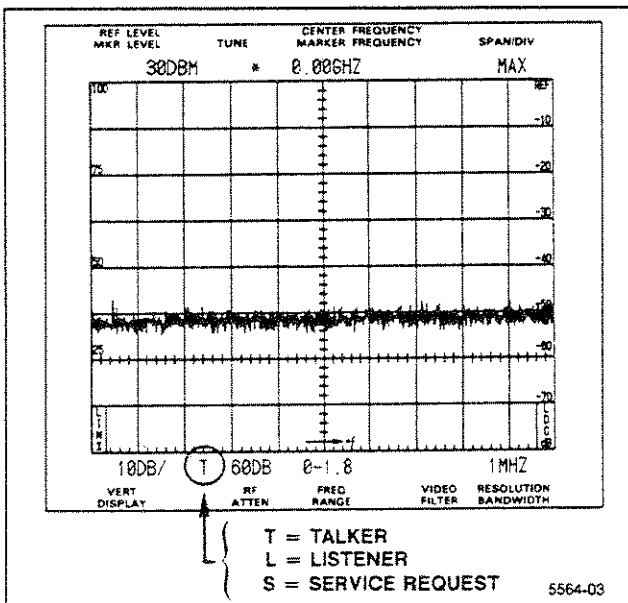

Figure 1-2. Status of active GPIB functions.

Setting the GPIB ADDRESS Switches

The rear-panel GPIB ADDRESS switches shown in Figure 1-3 set the value of the GPIB-address (refer to Table 1-1). The instrument's primary address (0 through 31) is the value of the lower five bits, which are labeled 4 through 8 in Figure 1-3. These switches are read each time power is turned on to the instrument and again each time the RESET TO LOCAL or PLOT pushbutton is pressed.

The address transmitted by the controller is seven bits wide. The first five bits are the primary address and the last two bits determine whether it is a listen address (32 + primary address) or talk address (64 + primary address). For example; 0100010 is primary address 2 a listener, and 1000010 is primary address 2 a talker. Secondary addresses (when both bits 6 and 7 are set) are not used by the spectrum analyzer, so are ignored.

Table 1-1
BUS ADDRESSES

	Primary Address	Listen Address	Talk Address
	16 8 4 2 1		
00000	0	32	64
00001	1	33	65
00010	2	34	66
00011	3	35	67
00100	4	36	68
00101	5	37	69
00110	6	38	70
00111	7	39	71
01000	8	40	72
01001	9	41	73
01010	10	42	74
01011	11	43	75
01100	12	44	76
01101	13	45	77
01110	14	46	78
01111	15	47	79
10000	16	48	80
10001	17	49	81
10010	18	50	82
10011	19	51	83
10100	20	52	84
10101	21	53	85
10110	22	54	86
10111	23	55	87
11000	24	56	88
11001	25	57	89
11010	26	58	90
11011	27	59	91
11100	28	60	92
11101	29	61	93
11110	30	62	94
11111	31	UNL	UNT

Set the switches as desired, but do not use address 0 with Tektronix 4050-Series controllers; they reserve this address for themselves. Selecting a primary address of 31 logically removes the spectrum analyzer from the bus; it does not respond to any GPIB address, but remains both unlistened and untalked. Remember, if you change these switches when the instrument is running, you must press RESET TO LOCAL or PLOT to cause the primary address to be updated.

Setting the LF OR EOI Switch

Switch 3 of the rear-panel GPIB ADDRESS switch (see Figure 1-3) selects the terminator for messages on the bus. If LF OR EOI is selected (switch up, 1), the spectrum analyzer interprets either the data byte LF or the end message (EOI asserted concurrently with a data byte) as the end of a message. If EOI is selected (switch

down, 0), the spectrum analyzer interprets the end message (EOI asserted as well as a data byte) as the end of a message.

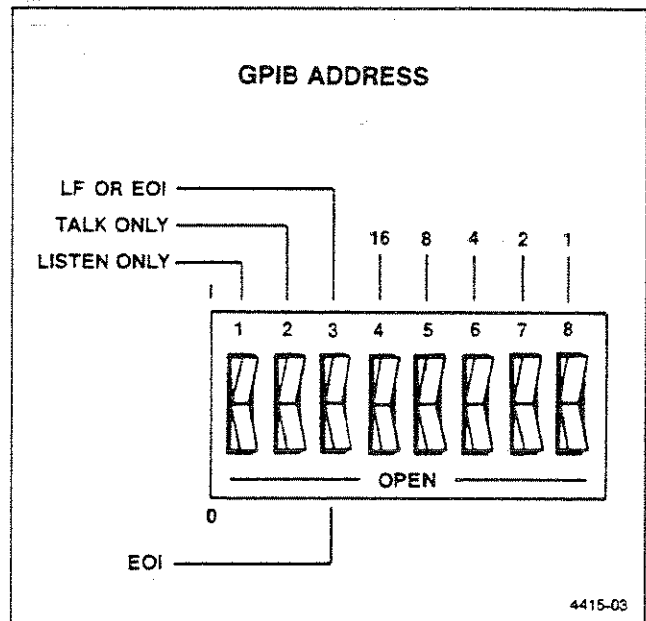

Figure 1-3. Rear-panel GPIB ADDRESS switches. The LF OR EOI switch (message terminator) and the TALK ONLY and LISTEN ONLY switches are part of the same switch band.

Switch 3 also selects the output terminator. Set to LF OR EOI, the instrument adds CR and LF (with EOI asserted as well as LF) after the last byte of the message. Set to EOI, the instrument asserts EOI concurrently with the last byte of the message.

Figure 1-4 shows the effect of this switch for both input and output.

Select EOI (switch down) for Tektronix controllers. The other position of this switch is provided to accommodate most other controllers. A change in this switch takes immediate effect.

Setting the TALK ONLY and LISTEN ONLY Switches

The spectrum analyzer switches for talk-only and listen-only operation are part of the GPIB ADDRESS switch bank shown in Figure 1-3. Set either or both of the switches up, 1. If instrument power is on, press RESET TO LOCAL or PLOT for a change in these switches to take effect. Both the TALK ONLY and LISTEN ONLY switches must be off (down, 0) when the spectrum analyzer is used with any controller.

IEEE 488 FUNCTIONS

The spectrum analyzer is compatible with IEEE Standard 488-1978. The connector and the signal levels at the connector follow the specifications in the IEEE 488 standard (refer to Appendix A in this manual for the basic concepts of the IEEE 488 standard). Table 1-2 lists interface capabilities as defined in the standard.

Table 1-2

SPECTRUM ANALYZER IEEE 488 INTERFACE FUNCTIONS

Function	Implemented As
Source Handshake	SH1
Acceptor Handshake	AH1
Talker	T5
Listener	L3
Service Request	SR1
Remote Local	RL1
Parallel Poll	PP1
Device Clear	DC1
Device Trigger	DT1
Controller	C0

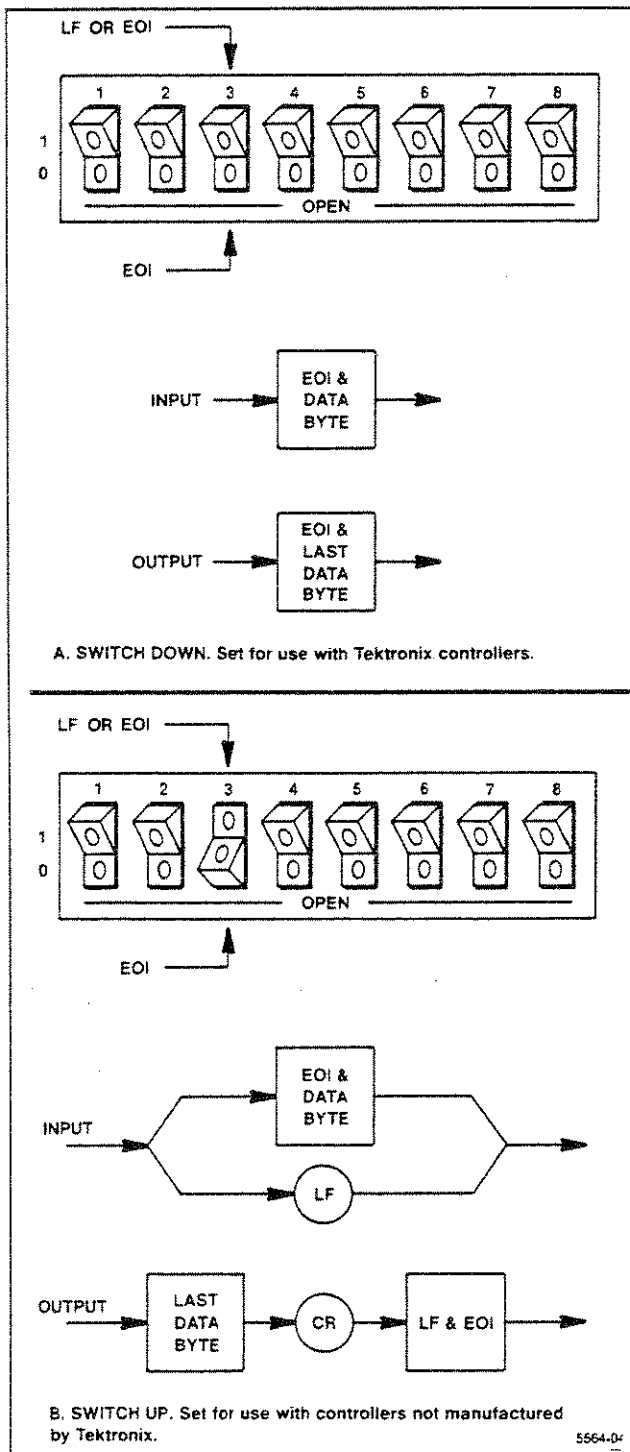

Figure 1-4. Effect of message terminator switch for input and output.

Source Handshake (SH1)

The spectrum analyzer has complete capability to transfer messages to other devices on the bus. Although tri-state drivers are used on the data lines, T1 (DAV delay for data setting) is greater than 2 μ s.

Acceptor Handshake (AH1)

The spectrum analyzer has complete capability to receive messages on the bus.

Talker (T5)

The spectrum analyzer has the complete talker function including serial poll; unaddresses as a talker when addressed as a listener. The instrument operates in a simple system in a talk-only mode if the TALK ONLY switch is set to 1, up.

Listener (L3)

The spectrum analyzer has the complete listener function; unaddresses as a listener when addressed as a talker. The instrument operates in a simple system in a listen-only mode if the LISTEN ONLY switch is set to 1, up.

Service Request (SR1)

The spectrum analyzer has the complete service request function; asserts SRQ (service request) for the conditions indicated under STATUS BYTE in Section 8 in this manual and reports the corresponding status when polled.

Remote/Local (RL1)

The spectrum analyzer has the complete remote/local function. The front-panel RESET TO LOCAL pushbutton returns the instrument from remote to local control unless the LLO (local lockout) message was previously received. The GTL (go to local) message also returns the instrument from remote to local control. Refer to the discussion under STATUS BYTE in Section 8 of this manual for the effect of busy status on remote/local transitions.

The current value of all programmable functions is maintained when switching from local to remote control. Only the value of TIME/DIV, MIN RF ATTEN dB, and PEAK/AVERAGE may change to match the front-panel control settings when switching from remote to local control, so they won't conflict with local control.

The spectrum analyzer must be under remote control to begin executing device-dependent messages that change the state of local controls or to load data into digital storage. Once begun, execution continues even if REN (remote enable) goes false. The spectrum analyzer changes settings for which there is no local control and outputs data while under local control.

Parallel Poll (PP1)

The spectrum analyzer responds to a parallel poll to indicate if service is requested.

Device Clear (DC1)

The spectrum analyzer responds to the DCL (device clear) and SDC (selected device clear) interface messages by resetting its input and output buffers to restart bus communications. When these messages are executed, they clear outstanding SRQ conditions and set the ERR query response to zero. Power-up status, if selected internally, is an exception; see STATUS BYTE in Section 8 of this manual for more on power-up status and for the affect of busy status on the execution of DCL and SDC.

Device Trigger (DT1)

The spectrum analyzer DT (device trigger) function allows the GET (group execute trigger) message to cause the instrument to stop the current sweep and rearm for the new sweep. The new sweep begins when the triggering conditions are met. The DT command must be on and the instrument must be in the Remote mode for GET to have any effect.

Controller (C0)

The spectrum analyzer does not act as a controller.

CONNECTING TO A SYSTEM

The programmable spectrum analyzer can be connected directly to a GPIB system with the cable supplied with the instrument as an optional accessory. The IEEE STD 488 PORT is shown in Figure 1-5. Printed under the IEEE STD 488 PORT are the Interface Function abbreviations and the codes indicating their use in the instrument (refer to IEEE 488 Functions earlier in this section for an explanation of each function). The E2 following the functions indicates that three-state drivers are used, rather than open-collector drivers, because of the high-speed operation of the instrument. To avoid interference on the bus, connect the instrument after turning on power or while the controller on the bus is turned off.

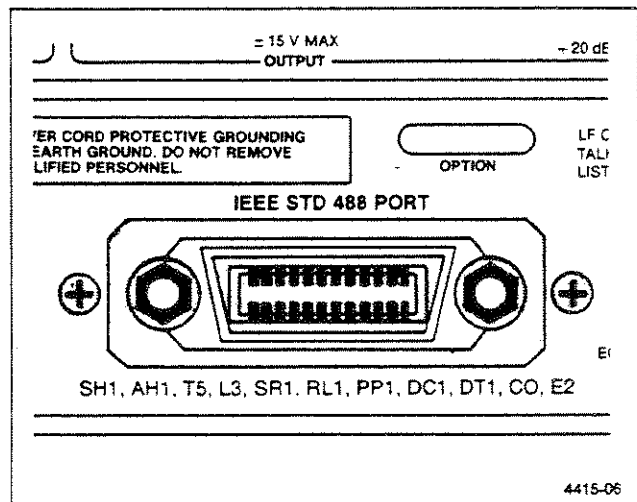

Figure 1-5. The rear-panel IEEE STD 488 PORT (GPIB).

The GPIB is a flexible system that works either in a star or linear pattern shown in Figure 1-6. Up to 15 devices can be connected at one time. To maintain bus electrical characteristics, no more than one 2-meter cable should be connected for each device (one for the controller, one for the spectrum analyzer, and so on),

and at least two-thirds of the devices connected must be on. (Appendix A details the IEEE STD 488 GPIB System Concepts.)

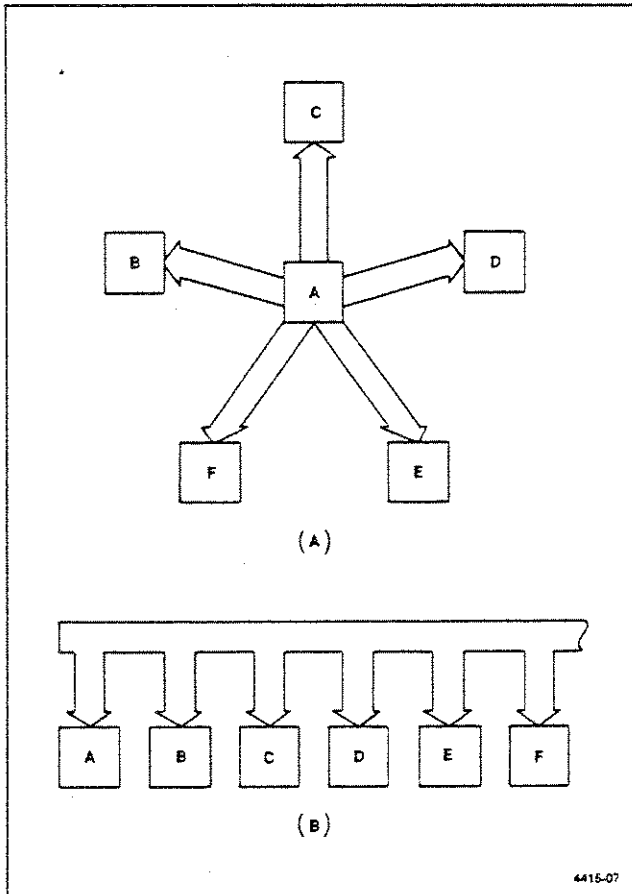

Figure 1-6. The spectrum analyzer can be connected to a GPIB system in either a star (A) or a linear (B) pattern.

An internal switch change causes the spectrum analyzer to assert SRQ when power is first applied. This requires immediate action by some controllers, so is not recommended for these controllers. Because changing the switch requires that the cover be removed, refer this task to qualified service personnel.

The instrument start-up procedure is provided in the Operators Manual. Refer to this manual for instructions on how to begin operating the instrument. Refer to the Accessories portion of the Replaceable Mechanical Parts list in the Service Manual, Volume 1, or your local Tektronix Field Office or representative for Manual ordering information.

The initial power-on setting of all programmable functions is restored by the INIT command. Refer to Section 8 of this manual for more on this command and a list of the initial power-on settings.

GETTING STARTED

Getting started with the spectrum analyzer on the GPIB is a simple matter if you are already familiar with a GPIB controller. If not, talking to the spectrum analyzer over the bus may be the easiest way to get over any uncertainty you feel about getting started.

The spectrum analyzer speaks a friendly language that includes codes for easier human understanding (mnemonics) for control of the front panel and to transfer measurement data. Put these mnemonics into GPIB input/output statements in your controller's language and you're on your way. Of course, your controller must handle details such as asserting REN, unaddressing bus devices, and addressing the spectrum analyzer to start communication; but, these are steps taken by most controllers when executing a GPIB I/O statement.

We have included some sample programs and exercises adapted for the TEKTRONIX 4041 System Controller.

NOTE

Some of the lines of input in examples of controller programs in this section extend beyond the column width limitations. Where this occurs, the overrun information is indented on the immediately-following line.

Important—Whenever a line is broken, it is always where a natural space occurs. So, be sure to add a space when inputting the program.

SETTING AND QUERYING PROGRAMMABLE CONTROLS

SETTING PROGRAMMABLE CONTROLS

We can keep this simple, because the programmable spectrum analyzer lets you make complex spectrum measurements semi-automatically. First we'll use the front-panel pushbuttons, then perform the same measurement under remote (GPIB) control using the 4041 controller.

Front-Panel Operation — Many measurements can be made with just three front-panel settings FREQUENCY, SPAN/DIV, and REF LEVEL.

The FREQUENCY setting changes the center frequency position of the spectrum window you are viewing, tuning the spectrum analyzer to change the frequency at the center of the crt.

The SPAN/DIV setting changes the size (width) of the window, setting the frequency span of the crt horizontal axis.

The REF LEVEL setting raises or lowers the window, which sets the amplitude level of the top graticule line on the crt.

Here's how to operate the spectrum analyzer to measure the CAL OUT signal, using the front-panel pushbuttons for these three settings.

1. Press the FREQUENCY 1 0 0 MHz pushbuttons to center the CAL OUT signal.

The spectrum analyzer automatically changes the frequency range, if necessary, as part of tuning to the 100 MHz signal.

2. Span down to look more closely at the signal by pressing the SPAN/DIV 1 MHz pushbuttons.

The spectrum analyzer automatically picks resolution bandwidth and time/division to fit the new span/division, unless Auto Resolution and Time Auto are cancelled. For most purposes, leave the TIME/DIV control set to AUTO so that Time Auto is in effect in either local or remote control, and leave Auto Resolution selected.

3. Press the REF LEVEL 2 0 -dBm pushbuttons to set the signal to the reference level.

The spectrum analyzer automatically selects the appropriate input attenuation and IF gain for a reference level at the power level of the CAL OUT signal's fundamental frequency. The spectrum analyzer takes into account the MIN RF ATTEN dB and MIN NOISE settings when positioning the attenuation and gain.

The spectrum analyzer powers up with the automatic modes active and in MAX SPAN to display all the frequencies in band 1. You can restore this condition at any time with the RESET command.

4041 Controller — How do steps 1, 2, and 3 in the last example work on a Tektronix 4041 controller? The spectrum analyzer commands are inserted in the following GPIB output statement PRINT. Throughout the 4041 BASIC examples in this manual, the variable Z has been used to represent the spectrum analyzer GPIB address. A constant in the range of 1 to 30 (matching the spec-

trum analyzer address) can be assigned to the variable Z.

```
80 Z=1 ! ADDRESS OF SPECTRUM ANALYZER
   EQUALS 1
100 Print #z:"FREQ 100 MHZ"
110 Print #z:"SPAN 1 MHZ"
120 Print #z:"REFLVL -20 DBM"
```

or

```
80 Z=1
100 Print #z:"FREQ 100 MHZ;SPAN 1 MHZ;REFLVL
   -20 DBM"
```

As this last statement shows, all three commands can be strung together, delimited by semicolons.

When the spectrum analyzer executes these commands, it tunes the CAL OUT signal to center screen, changes to the narrower span, and changes the reference level to display the signal peak at the top of the screen. Frequency range, resolution bandwidth, time/division, input attenuation, and IF gain are changed automatically, as necessary. Because the spectrum analyzer is calibrated for this display as part of the turn-on procedure, the signal peak should occur vertically at the reference level and horizontally at the graticule center. If not, refer to the Initial Turn On procedure in the Operators Manual or, better yet, try the automatic calibration routine described in <SHIFT> CAL under Display Parameters in Section 4 of the Operators Manual.

If you receive an SRQ message on the screen of the spectrum analyzer, add an SRQ handler to the program. This sequence can be added to any BASIC program example shown in this manual. The amended program would look like the following.

```
80 Z=1
90 On srq then call srq_hndi
100 Enable srq
110 Print #z:"FREQ 100 MHZ;SPAN 1 MHZ;REFLVL
   -20 DBM"
120 End
130 Sub srq_hndi
140 Integer status,adr
150 Poll status,adr;z
160 Print status;" -- ";
170 If status=97 then print "command error"
180 If status=98 then print "execution error"
190 If status=99 then print "internal error"
200 If status=101 then print "execution error warning"
210 If status=102 then print "internal error warning"
220 End
```

Whatever controller is used or statement is sent, the actions shown in the syntax diagram below must be taken to get a message to the spectrum analyzer.

The UNL (unlisten) and UNT (untalk) messages are optional in the previous syntax diagram of bus traffic. However, one or both are sent by most controllers when they begin transmitting and end transmitting on the bus, in order to guarantee a clear communications channel. The controller sends the GPIB address you entered as part of the controller's GPIB I/O statement. The controller either converts it to the spectrum analyzer listen address or expects to receive the listen address with the offset included (i.e., 32). The controller then sends the device-dependent message you inserted into the statement, and may finish by sending UNL and UNT. If the controller does not assert REN (remote enable) automatically for GPIB I/O, you can set it with an earlier control statement. The spectrum analyzer does not balk if REN is not set, unless you send commands that change front-panel settings or data in digital storage.

That leaves the most important part up to you; what goes in the controller statement as a device-dependent message. The spectrum analyzer control mnemonics are collected for quick reference on a Program Summary fold-out chart at the back of this manual. For details on how to state each command correctly and the instrument response, turn to the command descriptions that begin in Section 4 at the back of this manual. The detailed descriptions are arranged by function; (refer to the Index for page numbers).

The spectrum analyzer executes the message when it sees the message terminator (either EOI or LF). Message syntax and command execution are given fuller treatment in Section 3 of this manual.

Querying Programmable Controls

The spectrum analyzer returns the state of programmable controls when queried. This takes two steps.

1. Query the spectrum analyzer. The query takes the form of the mnemonic for a function name followed by a question mark.
2. Read the response. A GPIB INPUT statement does the job in the case of most controllers. The response will be returned as a character string with or without the applicable header, depending on whether the HDR command is ON or OFF; see the Header information in Section 3 of this manual.

For example, the Auto Resolution mode selected a resolution bandwidth to go with a span of the selected 1 MHz. What is that bandwidth? The query RESBW? readies the spectrum analyzer to output the answer.

The query can be included in any message to the spectrum analyzer. It is executed in its turn. This means that if RESBW? precedes the SPAN command in the previous example, the spectrum analyzer informs you of the old, rather than the new, resolution bandwidth. More than one query can be contained in a message to ask for both resolution bandwidth and, for instance, whether a video

filter is on. Just add these queries into the message used in the previous example and combine the message with the controller GPIB input statement.

```
110 Print #z:"FREQ 100 MHZ:SPAN 1 MHZ:REFLVL
    -20 DBM;RESBW?:VIDFLT?"
112 Input #z:p$
114 Print p$
```

If a query or command that has a lengthy response (e.g., CURVE?, SET?, WFMPRE) is included as part of this program, character string p\$ must be dimensioned large enough (at least 750) to accommodate the message.

Whatever the controller input statement, the actions shown in the syntax diagram below must be taken to receive a message from the spectrum analyzer.

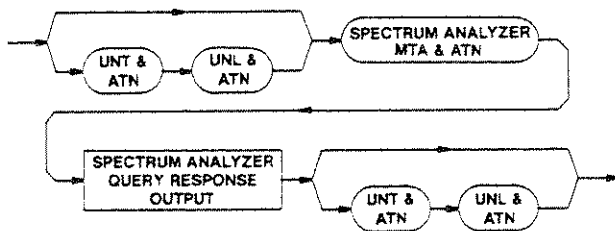

The PRINT and INPUT statements above describe the two steps necessary to get output from the spectrum analyzer. The PRINT statement includes the query sent to the spectrum analyzer. The INPUT statement receives the query response. In 4041 BASIC, both steps can be accomplished by a statement such as

```
input prompt "RES?:VID?"#z:p$
```

EXERCISE ROUTINES

Talk/Listen

Now let's put the statements for message I/O together to exercise the spectrum analyzer as a listener and a talker. This routine is handy because it waits for your input and sends it, time after time. If the spectrum analyzer responds with a message, the message is printed before another message is requested from you. Enter any of the commands or queries described in Sections 4 through 7 of this manual.

An SRQ handler is included in the routine to print out any error messages.

The following routine makes use of one of the friendly features of the spectrum analyzer. When the spectrum analyzer is talked with nothing to say, it outputs a byte with all bits set to one and asserts EOI. The routine

doesn't have to search the output character string for a ? (a query) and branch to input the response. Instead, the response is read after every message and printed (a blank line if the spectrum analyzer sends a byte with all ones).

The SRQ handler uses another spectrum analyzer feature. Rather than print a code for the status byte, the routine asks for the error that caused the SRQ (ERR?). This offers much more specific information about the problem. The meanings of the error and event codes are listed in Table 8-3 in Section 8 of this manual.

The routine assumes you have assigned the value of the spectrum analyzer address to variable Z as previously discussed. It is also assumed your input and output character strings will fit p\$ and r\$, respectively. This gets further attention with regard to the instrument settings query (SET?), our next topic.

```
200 On srq then call err_hndl
210 Enable srq
220 Print "ENTER MESSAGE: ";
230 Input p$Print P$
240 Print #z:p$Print "SRQ ";Q2
250 Input #z:r$
260 Print " ";r$
270 goto 200
280 End
300 Sub err_hndl
305 Integer e
310 Input prompt "err?" #z:e
320 Print " ERROR #err?" #z:e
330 Resume
340 End
```

Acquiring Instrument Settings with the SET Query

The SET query enables the controller to learn spectrum analyzer settings both for reference and to be able to restore the instrument to those settings. This query readies the instrument to output a message that includes a response for each programmable function.

The format of the response allows it to be used to restore the instrument settings with no operator manipulation required. First, set up for the measurement (and try it) from the spectrum analyzer front panel. Store the message as it is transmitted by the spectrum analyzer using the SET query. Your controller must be ready for a long character string. Dimension a string variable large enough for at least 750 characters for the SET query response, although the exact size depends on the current settings. Then, perform any desired instrument operations. Finally, restore the spectrum analyzer to the original settings by using the SET command to transmit the stored SET query response back to the instrument (a 4041 program follows that steps you through the operation).

```

300 Rem "This program stores/recalls spectrum
    analyzer front-panel settings"
302 Dim s$ to 750
310 Print "Press <Return> key to store settings";
320 Input k$ ! wait for return
330 Input prompt "set?" #z:s$
335 Print " Settings stored..."
340 Print "Press <Return> to recall settings to front
    panel";
350 Input k$ ! wait for return
360 Print #z:s$
365 Print " Settings recalled..."
370 End
    
```

Line 302 — Dimensions the string variable

Lines 310 through 335 — Inputs a SET? response to the spectrum analyzer.

Lines 340 through 365 — Returns a SET? response to the spectrum analyzer.

Resetting the Spectrum Analyzer and Interface Messages

The INIT command resets the instrument's programmable controls to their initial turn-on condition (see Section 8 in this manual for more on this command). INIT is sent in the same manner as other commands.

Interface message DCL (device clear) clears the instrument I/O buffers and can be used to restart bus communications with the spectrum analyzer. DCL does not interrupt message execution. If the spectrum analyzer is waiting for its talk address so it can execute an output query, output is stopped and the buffers are cleared by DCL, decimal code 20, or any device-dependent input. The decimal codes for other universal commands are 17 for LLO (local lockout), 21 for PPU (parallel poll unconfigure), 63 for UNL (unlisten), and 95 for UNT (untalk).

Addressed commands such as GTL (go to local) can also be sent to the 2754P. The codes for the addressed commands are 1 for GTL, 4 for SDC (selected device clear), 5 for PPC (parallel poll configure), and 8 for GET (group execute trigger). GET causes the spectrum analyzer to stop the current sweep and immediately start another sweep, synchronizing data acquisition with the interface message.

When the IFC (interface clear) line is asserted by the controller, as when the BASIC statement INIT is executed, the spectrum analyzer talker and listener functions are initialized (same effect as UNT and UNL).

Use the WBYTE statement to send the universal commands. For example, use this 4041 statement to send a device clear message on the bus.

```
100 WBYTE DCL
```

For addressed commands, include the primary address of the spectrum analyzer being talked to. For example, this 4041 statement sends a go to local command to the 2754P at address 3.

```
100 WBYTE GTL(3)
```

Acquiring a Waveform

The waveform in digital storage can be requested as either ASCII-coded decimal numbers or a block of binary data. To keep this simple, let's discuss the ASCII here and cover the binary with the WFMPRE command in Section 7 of this manual. When power is first applied to the spectrum analyzer, it is ready to transmit waveforms in ASCII (the WFMPRE command in Section 7 explains how to change modes).

Here is a program in 4041 BASIC that acquires an ASCII waveform. It gets a Full, 1000-point waveform with A and B memories merged (a power-up condition). Array wfm\$ in this program must be dimensioned to 5000.

```

100 Dim wfm$ to 5000
110 Input prompt "cur?" #z:wfm$
    
```

See Section 9 in this manual for help in plotting the waveform.

Getting Smarter

Signal analysis can be even easier. Put the spectrum analyzer to work to find and measure signals with its internal waveform-processing capabilities. The full set of waveform processing commands is described in Section 7 of this manual, and more instructions for their use are found in Section 9 of this manual. To get started "getting smarter", here is a simple application.

The following 4041 program catalogs the first 10 harmonics of the CAL OUT signal. If the instrument is set to other than the power-up state, precede the program with the INIT command. As in the other programs in this manual, Z is the variable that holds the value of the spectrum analyzer GPIB address.

```

80 Z=1 ! ADDRESS OF SPECTRUM ANALYZER
90 Print #z:"INIT"
100 ! CATALOG ROUTINE
110 Print #z:"SPAN 1 MHZ;REFLVL -20
    DBM;VIDFLT NARROW;SIGSWP"
120 For i=1 to 10
130 Print #z:"FREQ ",i*1.0E+8;";SIGSWP;WAIT"
140 Print #z:"FIBIG;TOPSIG;FREQ?;REFLVL?"
150 Input #z:r$
160 Print "SIGNAL ",i,r$
170 Print #z:"REFLVL -20 DBM"
180 Next i
    
```

Line 110 — Sets span/div and reference level for the start of the signal search, and selects narrow video filter to smooth the data for the routine. The single-sweep mode is selected so new data can be acquired on command.

Line 120 — Starts the loop.

Line 130 — Tunes to a harmonic of the calibrator signal, then starts a sweep to acquire new data. The WAIT guarantees digital storage is filled with updated data before proceeding.

Line 140 — FIBIG finds the calibrator harmonic (it should be the only signal on screen). TOPSIG automatically changes analyzer gain or input attenuation to bring the signal peak to the reference level (top of screen). These and other waveform processing commands allow you to analyze signals without reading in all the display data and operating on it in your controller.

Line 150 — Inputs the analyzer response.

Line 160 — Because the response to each query in line 140 begins with a mnemonic for the function, the analyzer output string acquired in line 150 is intelligible as is and the frequency and reference level readings are printed at the controller.

Line 170 — Readies the spectrum analyzer to do it again.

Line 180 — Goes around again.

The waveform processing commands and query allow you to analyze data without reading waveforms and manipulating them in your controller. More details can be found in Section 7 of this manual, and instructions for putting spectrum analyzer waveform processing to work are given in Section 9 of this manual.

Getting Smarter Another Way

The following 4041 program will measure the amplitude and frequency of the 100 MHz CAL OUT and the next 9 harmonics of the CAL OUT signal.

```

80  Z=1 ! ADDRESS OF SPECTRUM ANALYZER
500  Dim m(10)
510  Open #z:"gpib(pri=1,eom=<0>,tim=100):"
520  Print #z:"init:time auto;min 0;span 1m;ref -20"
530  Print #z:"rlm mnoise;vid nar;step 100m;sig"
540  Print #z:"pstep;sig;wai;mfbig;mampl?;rep 9"
550  Input deln "" #z:m
560  Print m

```

Lines 500 and 510 — Dimensions array m and sets the primary address and 4041 data transfer timeout to 100 sec.

Line 520 — Initializes the spectrum analyzer and sets the time/division, minimum attenuation, frequency span, and reference level.

Line 530 — Sets the reference level mode and video filter, establishes a step size of 100 MHz, and enters the single sweep mode.

Line 540 — Increases the primary marker frequency by the step value (100MHZ), starts a sweep, waits until the end of sweep, finds the largest on-screen signal, and requests the marker frequency and marker amplitude, and then repeats the sequence 9 times.

Line 550 — Inputs all 10 marker frequencies and marker amplitudes.

Line 560 — Prints all 10 marker frequencies and marker amplitudes.

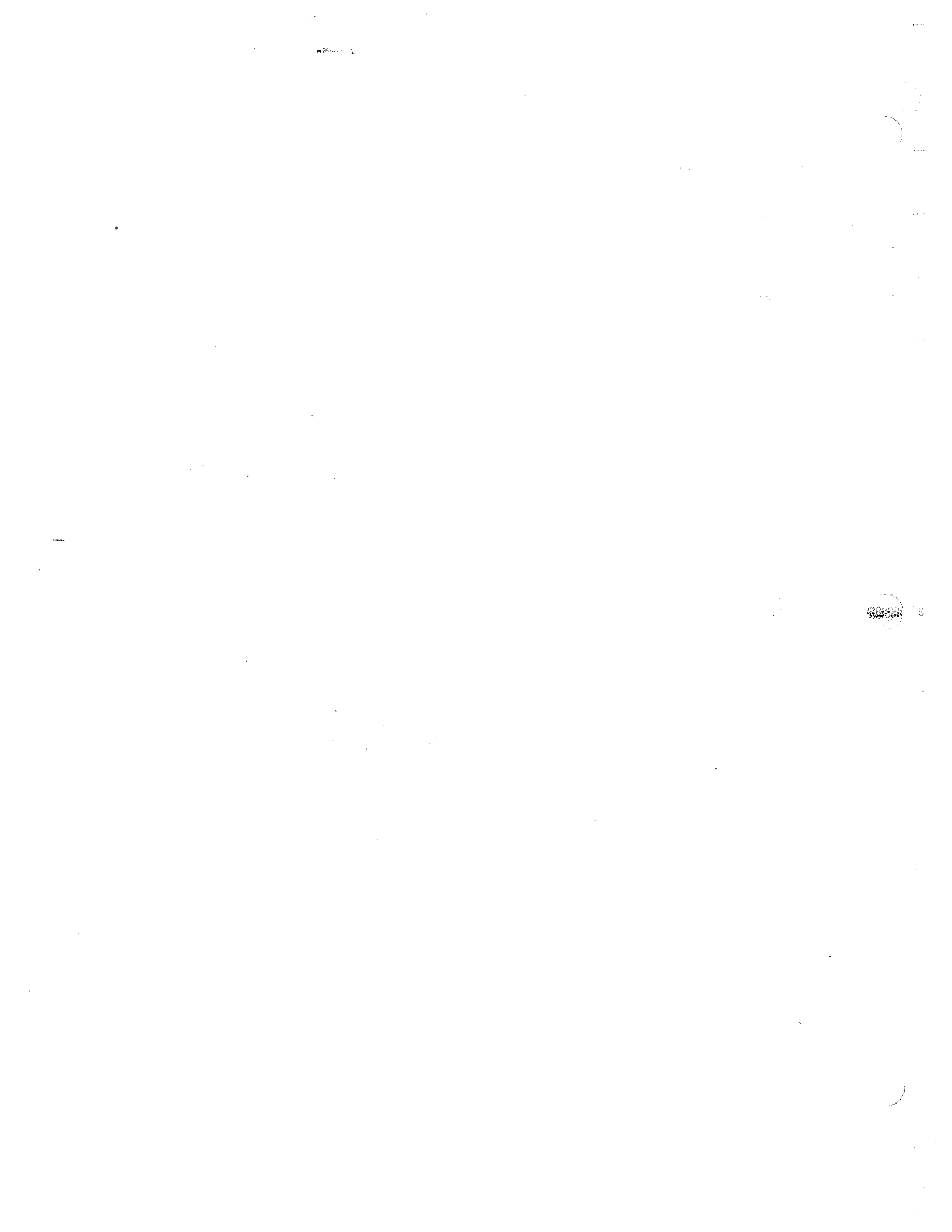

DEVICE-DEPENDENT MESSAGE STRUCTURE AND EXECUTION

The goal of the spectrum analyzer device-dependent message structure is to enhance compatibility with a variety of GPIB systems, yet be simple and obvious to use.

This goal is achieved within the framework of the Tektronix Interface Standard for GPIB Codes, Formats, Conventions, and Features. This standard is intended to make messages on the bus clear and uncomplicated, while allowing the instrument to handle messages in a friendly manner (i.e., to accept variations in the message). Compatibility with existing devices is maintained as much as possible, while use of codes and data formats is encouraged to make maximum use of bus capabilities.

To make spectrum analyzer messages easy to understand and write, ordinary engineering terms are used. Message codes (mnemonics) are chosen to be short, yet remind you of their function. For example, to set the instrument center frequency to 500.000 MHz, the message `FREQ 500.000 MHZ` could be sent over the bus after the instrument has been addressed as a listener. Variations on this message are allowed to make it shorter or send the frequency in scientific notation, but this example shows the conversational format of spectrum analyzer messages that makes them readable; therefore, human-oriented.

The spectrum analyzer device-dependent messages in this manual are downward compatible with the Tektronix 490P-Series spectrum analyzers, except as noted later in this section under 490P-490AP/2750P Series Compatibility.

SYNTAX DIAGRAMS

Spectrum analyzer messages are presented in this manual in syntax diagrams that show the sequence of elements transferred over the bus. Each element is enclosed in a circle, oval, or box.

Circles or ovals contain the mnemonics for literal (terminal entry) elements; i.e., a character or string of characters that must be sent exactly as shown. Because most mnemonics may be shortened, the required characters in command and query literal elements (i.e., the first three characters of the element) are shown larger than optional characters. Although mnemonics are shown all upper case, the spectrum analyzer accepts either upper-case or lower-case ASCII characters. Query response characters are shown exactly as they will be returned.

Boxes are used for defined elements and contain a name that stands for the element defined elsewhere. NUM is such a name and is defined under Numbers later in this section.

Elements of the syntax diagram are connected by arrows that show the possible paths through the diagram (i.e., the sequence in which elements must be transferred). Parallel paths mean that one, and only one, of the paths must be followed; while a path around an element or group of elements indicates an optional skip. Arrows indicate the direction that must be followed (usually the flow is to the right; but, if an element may be repeated, an arrow returns from the right to the left of the element). Some examples of such sequences follow.

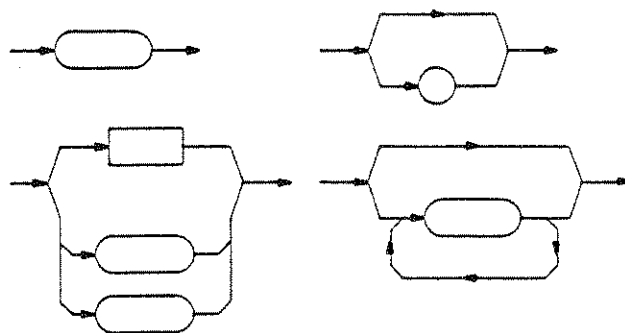

SPECTRUM ANALYZER INPUT MESSAGES

Input Message Format

A remote control message to the spectrum analyzer comprises one or more message units of two types. The message units either consist of commands that the spectrum analyzer inputs as control or measurement data, or they consist of queries that request the spectrum analyzer to output data.

One or more message units can be transmitted as a message to the spectrum analyzer. Message units contain ASCII characters (binary may also be used for waveforms). The spectrum analyzer accepts either upper-case or lower-case characters for the mnemonics shown in the syntax diagrams.

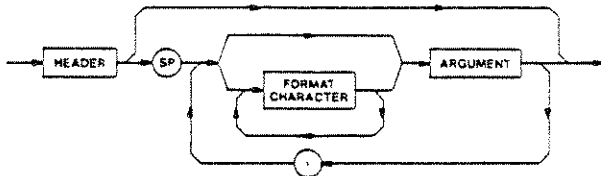

Message Unit Delimiter (;)

Message units are separated by a semicolon (;). A semicolon is optional following the last message unit.

Message Terminator (TERM)

The end-of-message terminator may be either the END message (EOI asserted concurrently with the last data byte), or the ASCII code for line feed (LF) sent as the last data byte.

The active terminator is selected by the rear-panel GPIB ADDRESS switch 3.

Format Characters

Format characters may be inserted at many points to make the message more intelligible, but are required only if they are included as a literal element (i.e., in circles or ovals) with no bypass. Allowable format characters are SP (space), CR (carriage return), and LF (line feed — unless the end of message terminator is set for LF), as well as all other ASCII control characters and comma (,). At some points in a message, the spectrum analyzer may accept other non-alphanumeric characters, such as quotation marks (").

Input Buffering and Execution

The spectrum analyzer buffers each message it receives with a capacity that exceeds that required for the SET? response. The spectrum analyzer waits until the end of the message to decode and execute it. A command error in any part of a message prevents its execution. When the instrument is under local control, commands that would conflict with local control are ignored (see Remote/Local under IEEE 488 Functions in Section 1 of this manual).

If the message contains multiple message units, none are acted on until the instrument sees the end-of-message terminator. When the spectrum analyzer sees the termi-

nator, it executes the commands in the message in the order they were received. The instrument remains busy until it is done executing the commands in the buffer, unless the process is stopped by the DCL (Device Clear) or SDC (Selected Device Clear) interface messages. While busy, further input is not accepted (see STATUS BYTE in Section 8 in this manual for more on busy status). Output, if requested, is begun only after the entire input message is executed.

Because display (measurement) data input and output and waveform processing share the same buffer, conflicts can arise. This is discussed in the Interaction part of the CURVE command in Section 6, under Display Data Point Commands Interaction in Section 7, and is further expanded on under Multiple Use of Display Buffer For Waveform Processing and I/O in Section 9, all in this manual.

Command Format

A command message unit either sets an operating mode or parameter, or it transfers display data to the instrument. The command format to set a mode or parameter includes the following possible paths.

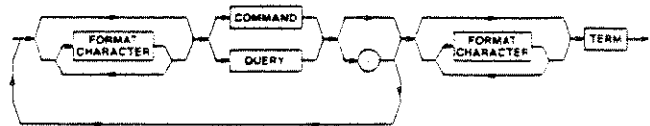

Because the general command format for display data transfers is complicated, it is omitted; see the data I/O commands in Section 6 of this manual for the specific command syntax.

Header

Header elements are mnemonics that represent a function; for example, FREQ for center frequency and CURVE for the display trace. The header for query responses can either be turned on or off (refer to Query Response Format later in this section).

Header Delimiter (SP)

A space (SP) must separate the header from any argument(s).

Argument Delimiter (,)

A comma (,) must separate multiple arguments.

Argument Format

The following diagram illustrates that arguments following the header may be a number, a group of characters, or either a number or a group of characters linked to a character argument.

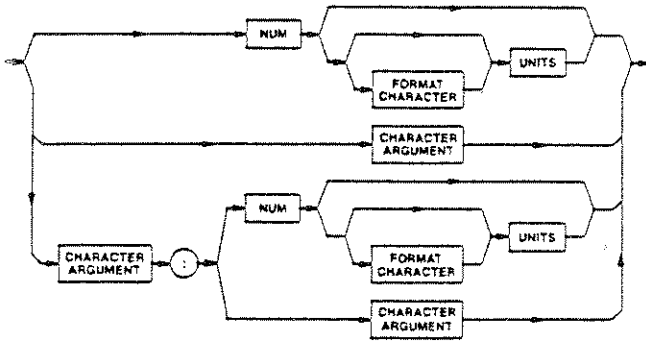

Numbers

The defined element NUM is a decimal number in any of three formats; NR1, NR2, or NR3. NR1 is an integer (no decimal point).

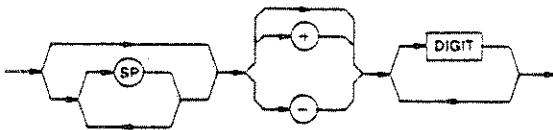

NR2 is a floating point number (decimal point required).

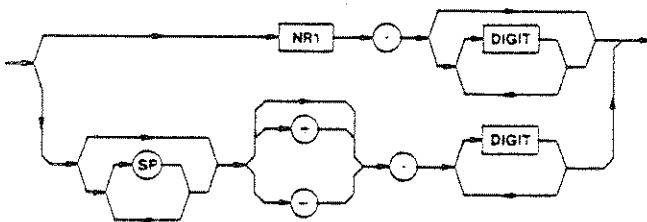

NR3 is a floating point number in scientific notation.

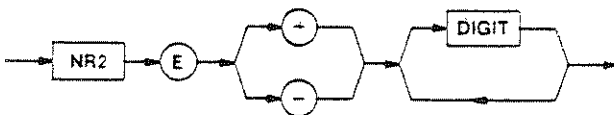

NUM arguments may serve two functions. The first is to select the value of a continuous function (for example, the center frequency with FREQ). In this case, if NUM exceeds the range of the function, the spectrum analyzer

does not execute the command, but issues an error message (see PEAK and POINT in Sections 4 and 6, respectively, in this manual for exceptions). Numbers within the range are rounded.

The second function of a NUM argument is to substitute for character arguments in ON/OFF or mode selection. In this case, if NUM exceeds the selection range, it is rounded to the nearest end of the range. No error message is issued. Numbers within the range are rounded.

Units

The spectrum analyzer accepts arguments in engineering notation; that is, engineering units may be appended to a number argument. The instrument treats the combined number and units as scientific notation where the first letter of the units element represents a power of 10. K=1E+3, G=1E+9, and M=1E-3 or M=1E+6 (the value of M depends on the function, where MSEC stands for 1E-3 (milliseconds) in the TIME (time/div) command, and MHZ stands for 1E+6 (megahertz) in the SPAN (span/div) command). Only the first letter of the units element is of importance; the rest of the units element (i.e., SEC or HZ) does not contribute to the value of the command argument and can be omitted. This does not apply to the dBm and dBmV units in use with the RLUNITS, REFLVL, and MAXPWR commands, where all letters must be used to avoid an error. Although more than one format character may precede the units, only a space (SP) is shown in the command syntax diagrams in this manual.

Character Argument

Arguments may be either words or mnemonics. ON and OFF, for instance, are arguments for the commands that correspond to spectrum analyzer front-panel push-buttons like 10dB/DIV or VIEW B.

Link Argument

The bottom path in the argument diagram combines both character and number arguments in a link argument. The link is the colon (:), which delimits the first and second arguments. For example, the VRTDSP (vertical display) command employs link arguments to make scale factors available.

String Argument

A string argument is used when a message is to be displayed on a printer, plotter, or display unit for human interpretation, as with the RDOUT command. The characters are enclosed in quotes to delimit them as a string

argument.

Query Format

A query message unit requests either function or display data from the instrument. The query message unit format is shown below.

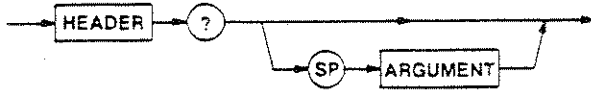

Query Response Format

A query reads the spectrum analyzer for output. In query responses, the response header can either be returned with the response, or not returned (this depends on whether the HEADER command is turned ON or OFF). The output message format in response to a mode or parameter is as follows.

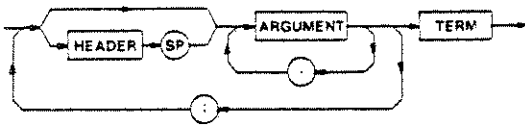

Binary Block

Binary block is a sequence of binary numbers that is preceded by the ASCII code for percent (%) and a two-byte binary integer representing the number of binary numbers plus one (the extra byte is the checksum) and followed by the checksum. The checksum is the 2's-complement of the modulo-256 sum of all preceding bytes except the %. Thus, the modulo-256 sum of all bytes except the % should equal zero to provide an error-check of the binary block transfer.

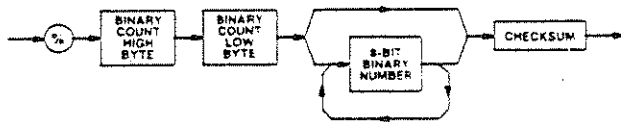

End Block

End block binary is a sequence of binary numbers that is preceded by the ASCII code for at (@); EOI must be asserted concurrently with the last data byte. The end block can only be the last data type in a message.

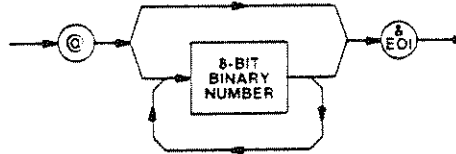

SPECTRUM ANALYZER OUTPUT MESSAGES

When the spectrum analyzer executes a query, it buffers an output message unit that is a response to the query. Output message units contain ASCII characters (except when a binary waveform is requested).

Output Message Format

The output message unit combines the header and appropriate argument(s). Message units are combined if the output includes a response to the SET query or to more than one query. The header for query responses can either be turned on or off.

Output Message Execution

The spectrum analyzer begins output when talked, and it continues until it reaches the end of the information in its buffer or is interrupted by a DCL (Device Clear), UNT (Untalk), or IFC (Interface Clear) message. If the spectrum analyzer is interrupted and the buffer is not cleared, the spectrum analyzer will resume output if it is retalked. The buffer may be cleared by the DCL messages, or if it is listened, by the SDC message or any device-dependent message. If not interrupted, the spectrum analyzer terminates the output according to the setting of the EOI OR LF switch.

490P-490AP/2750P SERIES COMPATIBILITY

Most of the primary modes of the 490AP/2750P-series controls and functions are identical to those of the 490P-series. Following are some of the areas where operations or results will differ.

GPIB

2754P/492AP — The DCL interface message is handled by interrupts and will stop execution of the command in progress.

492P — The processor is required to not be busy (e.g., executing a WAIT message) in order for DCL to be handshook in.

DEGAUS Command

2754P/492AP — DEGAUS may be executed in any span.

492P — DEGAUS may be executed in spans ≤ 1 MHz/div or less.

IDENT Command

2754P/492AP — The span must be ≤ 50 MHz or less for coaxial bands (0–21 GHz)

492P — The span must be at 500 kHz/div.

PEAK Command

2754P/492AP — A PEAK value is stored for each band. In preselected bands (with Option 01) a value is stored every 500 MHz.

492P — The same value is used for all bands.

494P — One PEAK value is stored for each band.

Readout Maximum

2754P/492AP — Readout strings can contain up to 40 characters.

492P — Readout strings can contain up to 32 characters.

Service Requests

2754P/492AP — RQS is the master mask for service requests, and both RQS and EOS must be on to cause end-of-sweep service requests.

492P — RQS masks error service requests and EOS masks end-of-sweep service requests. Only EOS must be on for end-of-sweep service requests.

Affect of Busy on Device-Dependent Messages

2754P/492AP — Interface messages are processed despite busy status. If RTL interrupts a message, the spectrum analyzer executes the remainder of the message before restoring local control. The response of the spectrum analyzer to interface messages depends on the manner in which they are handled. Some interface messages are handled by the GPIB interface, while others require action by the microcomputer. The latter generally involve the GPIB address, and are implemented in firmware rather than on the interface. The speed with which these commands can be handshaked depends on how fast the spectrum analyzer can service the resulting interrupt.

492P — Interface messages are processed despite busy status if the busy status occurs because the spectrum analyzer is executing a WAIT command. If RTL interrupts WAIT, the spectrum analyzer attempts to execute the remainder of the message after restoring local control and waiting for EOS.

If the busy status occurs because the spectrum analyzer is executing any device-dependent message other than WAIT, the response is handled the same as described for the 492AP.

GET (Group Execute Trigger)

2754P/492AP — GET requires firmware action, so handshake occurs only when the interrupt can be handled. The effect of GET is masked by DT (Device Trigger).

492P — Handshake occurs only when the microcomputer is not executing a device-dependent message unit other than WAIT.

EVENT?/ERR? Codes

2754P/492AP — Bit 5 reflects the current condition, and a serial poll clears the EVENT? status that was reported. Only one Command Error is saved (i.e., the category code of the first Command Error will be reported, and any succeeding Command Errors will be ignored). All errors from other categories (Execution Errors, Internal Errors, System Events, Execution Warnings, and Internal Warnings) are saved and reported. Refer to Section 8 for information on the Status and Error Reporting.

492P — Bit 5 reflects the current condition, and a serial poll clears the ERR? status that was reported. All errors, regardless of category, are saved. GET is not masked.

Preserving Frequencies

2754P/492AP — Band changes (except in MAX span) will attempt to preserve oscillator frequencies. They will set to a band limit if the oscillator frequencies would cause an out-of-band center frequency. If the spectrum analyzer is not tuned after a band change and is returned to the original band (except in MAX span), the center frequency will be the same as that before the band changes.

492P — The original center frequency will not be preserved. The spectrum analyzer will just check to see if the oscillator frequencies will cause an out-of-band frequency or not.

MINATT Command

2754P/492AP — MINATT always set from MAXPWR by limiting the power at the first mixer to -18 dBm.

492P — MINATT set using -10 dBm for non-preselected band and -18 dBm for the preselected bands.

Reference Level

2754P/492AP — The minimum reference level is -127 dBm. The delta-amplitude range is 57.75 dB and slides depending on the reference level when the delta-amplitude mode is entered. The range slides from a 0 to -57.75 range to a +9 to -48.75 dB range. If the entry level is on a 10 dB step, the range is 0 to -57.75 dB. If the entry level is not on a 10 dB step, the range is (next 10 dB step-entry level) to 57.75 dB lower (e.g., entering delta amplitude at -19 dBm will cause the range to be +9.00 to -48.75 dB).

492P — The minimum reference level is -123 dBm. The delta-amplitude range is 63.75 dB. The range slides from a 0 to -63.75 range to a +10 to -53.75 dB+10 to -53.75 dB. However, the range may be 0 to -63.75 in the minimum noise mode.

RDOUT Command

2754P/492AP — The remote-to-local transition will always return RDOUT to NORMAL (i.e., any messages sent to the crt with RDOUT commands will be replaced by the regular crt readout).

492P — If the remote-to-local transition occurs after UNT or UNL, messages sent to the crt via RDOUT may be retained on the screen. The regular crt readout will be returned by changing any control whose current condition is reported on the crt.

INSTRUMENT CONTROL

Commands and queries for instrument control are grouped in this section according to the following functions.

Frequency
 Frequency Span and Resolution
 Vertical Display and Reference Level
 Sweep Control
 Digital Storage
 Display Control
 General Purpose

The mnemonics (codes) in Table 4-1 correspond to the spectrum analyzer names for the front-panel push-buttons and controls and related functions.

Table 4-1
 FRONT-PANEL COMMANDS AND QUERIES

Name	Mnemonic
Frequency	
FREQUENCY	FREQ
CENTER/MARKER FREQUENCY	TUNE
TUNE CF	TMODE
1ST LO ^a	FIRST
2ND LO ^a	SECOND
Disable Tuning Corrections ^a	DISCOR
ΔBAND/BAND▽	FRQRNG
STEP ENTRY & STEP SIZE	STEP
-STEP	MSTEP
+STEP	PSTEP
FREQ START STOP	STSTOP
Δ F	DELFR
Degauss ^a	DEGAUS
IMPEDANCE ^b	IMPED

^aThese commands are related to front-panel control functions; they are not actually labeled on the front panel.

^b with Option 07 installed.

Table 4-1 (cont)

Name	Mnemonic
Frequency Span and Resolution	
FREQUENCY SPAN/DIV & SPAN/DIV	SPAN
ZERO SPAN	ZEROSP
MAX SPAN	MXSPN
RESOLUTION BANDWIDTH	RESBW
AUTO RES	ARES
IDENT	IDENT
Vertical Display and Reference Level	
10dB/DIV	VRTDSP
2dB/DIV	
LIN	
dB/DIV	
REFERENCE LEVEL & REF LEVEL	REFLVL
REF LEVEL UNITS	RLUNIT
CAL	CAL
Enable Calibration Factors ^a	ENCAL
FINE	FINE
MIN NOISE MIN DISTORTION	RLMODE
MANUAL PEAK	PEAK
MIN RF ATTEN dB	MINATT
	MAXPWR
RF Attenuation ^a	RFATT
PULSE STRETCHER	PLSTR
WIDE VIDEO FILTER	VIDFLT
NARROW VIDEO FILTER	
Sweep Control	
FREE RUN	TRIG
INT	
LINE	
EXT	
SINGLE SWEEP	SIGSWP
TIME/DIV	TIME
Digital Storage	
VIEW A	AVIEW
VIEW B	BVIEW
SAVE A	SAVEA
B-SAVE A	BMINA
STORE	DSTORE
RECALL DISPLAY	DRECAL
MAX HOLD	MXHLD
PEAK/AVERAGE	CRSOR
Display Control	
READOUT	READOUT
GRAT ILLUM	GRAT
BASELINE CLIP	CLIP
Tracing ^a	TRACE

Table 4-1 (cont)

Name	Mnemonic
General Purpose	
Header	HDR
STORE	STORE
RECALL SETTINGS	RECALL
PLOT?	PLOT?
Plotter Type Selection ^a	PTYPE
Plot (B-A) Reference ^a	POFSET

The following controls and adjustments are operated only from the instrument front panel (no remote control).

- INTENSITY
- MANUAL SCAN
- POSITION ◀▶◆
- AMPL and LOG CAL
- POWER
- PEAK/AVERAGE cursor (other than fully counter-clockwise or clockwise positions).

FREQUENCY

The commands in this group set and change the spectrum analyzer center frequency (FREQ, TUNE, and STSTOP), set the 1ST LO (FIRST) and the 2ND LO (SECOND) frequencies, disable tuning corrections (DISCOR), select the frequency range (FRQRNG), set frequency step size (STEP), decrease or increase center frequency (MSTEP, PSTEP), set start-stop frequencies (STSTOP), and start the delta-frequency function (DELFR). Instruments with Option 07 installed change between the 50-Ω and 75-Ω inputs (IMPED). (DEGAUS) is included in all instruments to maintain software compatibility.

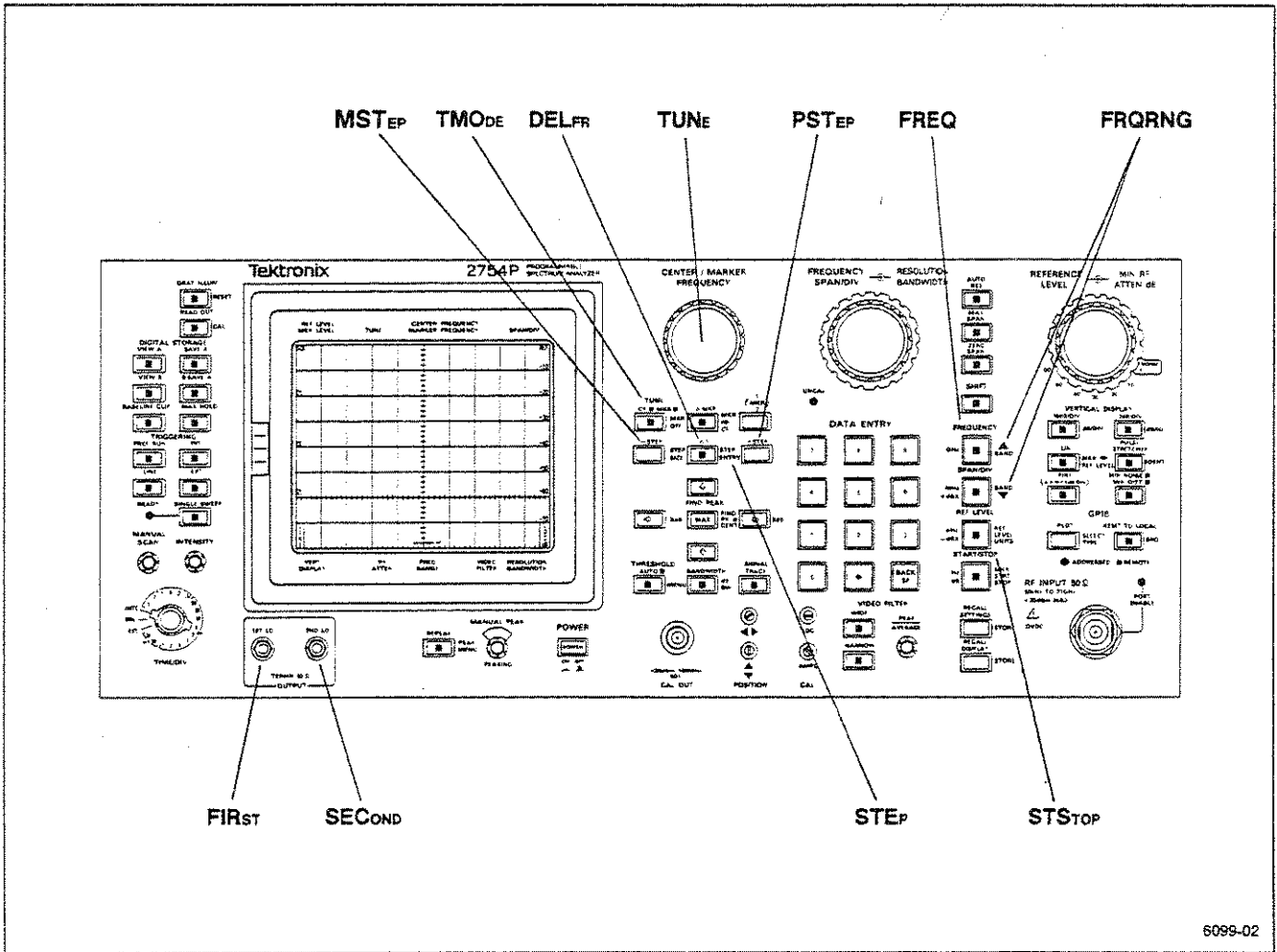
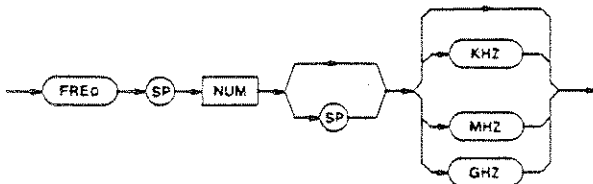

Figure 4-1. Front-panel Frequency commands.

FREQ (center frequency) command



NUM — The spectrum analyzer centers its span about the value in the command argument. If that frequency is not within the current band, the instrument selects the nearest band to the current band that includes the value. The range of values and resolution of the instrument response are the same as for front-panel operation.

Examples — FREQ 200MHZ
 FREQ 100,000
 FRE 200 KHZ

Range — 0 Hz to 21 GHz

Power-up value — 0 MHz

Interaction — An automatic degauss is done when **FREQ** is changed >1 GHz, to improve amplitude accuracy when using the preselector in Option 01 instruments.

FREQ (center frequency) query

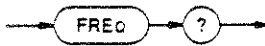

Response to FREQ query

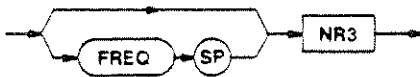

TUNE (incremental frequency change) command

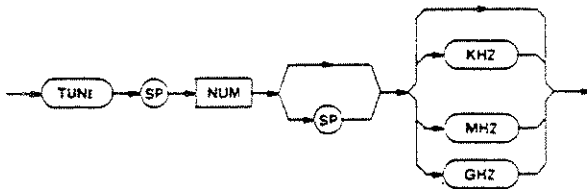

NUM — The spectrum analyzer changes its center frequency by using the value of the command argument as an offset to its previous center frequency. If the frequency is not within the current band, the command fails and execution error message 28 is issued.

Examples — TUN 10 MHZ
 TUNE1.0E6
 TUNE 100 KHZ

There is no TUNE query.

TMODE (set tune mode) command

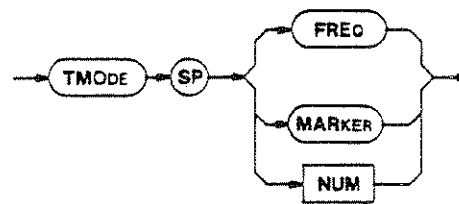

MARKER — The front-panel CENTER/MARKER FREQUENCY control will tune the marker.

FREQ — The front-panel CENTER/MARKER FREQUENCY control will tune the center frequency.

NUM — 0 = OFF
 1 = SINGLE or ON
 2 = DELTA

Power-up value — FREQ.

Interaction — If **MARKER** is OFF, **TMODE** **MARKER** sets **MARKER** to SINGLE. **TMODE** has no other effect on GPIB operation; it merely sets the tuning mode that the front-panel CENTER/MARKER FREQUENCY knob will have when the analyzer is returned to local control.

TMODE (tune mode) query

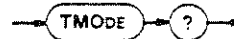

Response to TMODE query

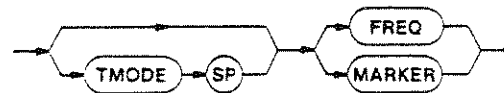

FIRST (1ST LO frequency) command

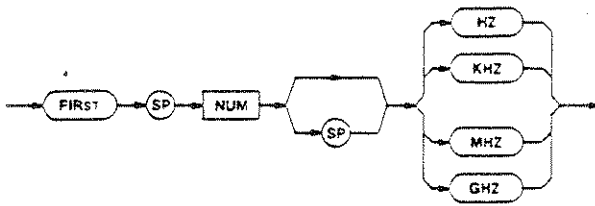

NUM — The spectrum analyzer 1ST LO is set to the requested frequency. The resulting center frequency will be displayed. If the requested frequency is not within the current band, the command fails, and execution error message 28 is issued.

Examples — FIR 2.3 GHZ
FIRST 2.3 GHZ

Power-up value — 2072 MHz.

- Range** — Band 1; 2072 MHz to 6212 MHz (Standard Instrument)
 Band 1; 2072 MHz to 872 MHz (Option 01)
 Band 1; 2072 MHz to 3072 MHz (Option 07 when 75 Ω input in use)
 Band 2; 2529 MHz to 6329 MHz
 Band 3; 2171 MHz to 6271 MHz
 Band 4; 2076 MHz to 6276 MHz
 Band 5; 4309 MHz to 6309 MHz

FIRST (1ST LO frequency) query

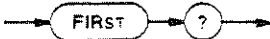

Response to FIRST query

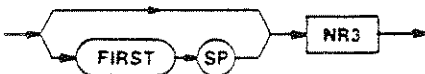

SECOND (2ND LO frequency) command

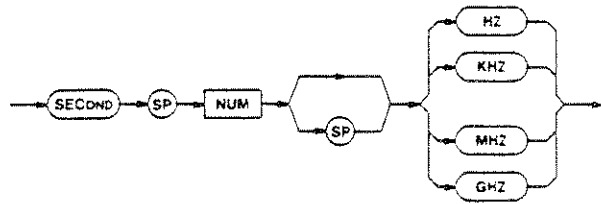

NUM — The spectrum analyzer 2ND LO is set to the requested frequency. The resulting center frequency will be displayed. If the requested frequency is not within the current band, the command fails, and execution error message 28 is issued.

Examples — SEC 719 MHZ
SECOND 2182 MHZ

Range — Bands 2, 3, and 4; 718.67 MHz to 719.33 MHz

All other bands; 2181 MHz to 2183 MHz

Power-up value — 2182 MHz.

SECOND (2nd LO frequency) query



Response to SECOND query



DISCOR (disable tuning corrections) command

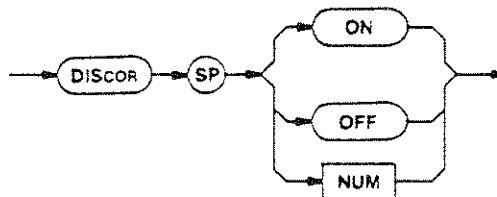

This command is included to allow disabling of the frequency control loop in the spectrum analyzer for speed or diagnostics purposes. It will also allow a fall-

back to low accuracy center frequency operation if the frequency control loop fails.

- ON — Center frequency correction are disabled.
- OFF — Center frequency corrections are enabled.

DISCOR (disable tuning corrections) query



Response to DISCOR query

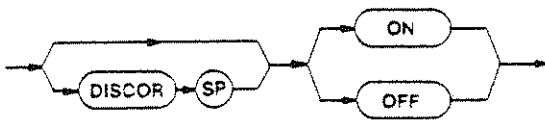

FRQRNG (frequency range) command

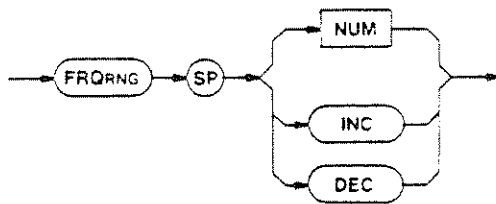

NUM — The spectrum analyzer accepts number arguments in the range of 1 through 5 and changes the frequency range accordingly. Non-integer values are rounded. If the number is too large or too small, the instrument maintains its current frequency range and reports execution error message 29. In Option 07 instruments, if the requested frequency range is outside the allowable limits (if you send anything except FRQRNG 1), execution error message 102 is issued.

INC — The spectrum analyzer changes to the next higher frequency range, if possible. If this cannot be done, execution error message 29 is issued.

DEC — The spectrum analyzer changes to the next lower frequency range, if possible. If this cannot be done, execution error message 29 is issued.

Range — 1 to 5.

Power-up value — Frequency Range 1.

Interaction — The spectrum analyzer automatically selects the frequency range closest to the present that includes the frequency setting in response to the FREQ command.

FRQRNG (frequency range) query



Response to FRQRNG query

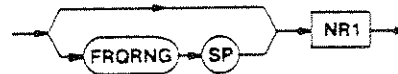

STEP (step size) command

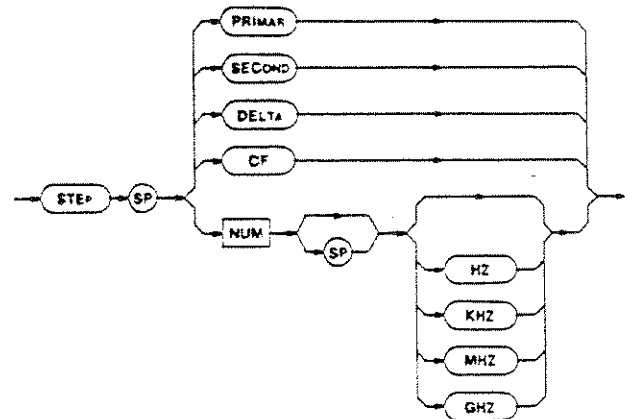

The STEP command sets the frequency step size used by the MSTEP and PSTEP commands.

PRIMAR — Sets the step size to the absolute value of the primary marker.

SECOND — Sets the step size to the absolute value of the secondary marker.

DELTA — Sets the step size to the absolute value of the difference in frequency between the primary and secondary markers.

CF — Sets the step size to the absolute value of the center frequency.

NUM — Sets the step size to the frequency input.

Examples — STE DEL
 STE PRIMAR
 STEP SEC

STE 100 Hz
 STEP 20 KHZ
 STE 100 MHZ

Range — 0 Hz to 21 GHz.

Interaction — STEP DELTA causes marker execution error message 123 to be issued if MARKER is not set to DELTA. If STEP has not been set, MSTEP and PSTEP set STEP to the absolute value of the center frequency if in the Tune CF mode, to the absolute value of delta marker frequency if delta markers are on and in the Tune Marker mode, or to the absolute value of the primary marker frequency if delta markers are off and in the Tune Marker mode.

STEP (step size) query



Response to STEP query

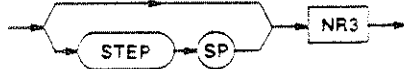

MSTEP (minus step) command

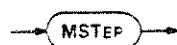

This command decreases the center frequency, if you are in the tune frequency mode, by the value set in the STEP command, if possible. If you are in the tune marker mode, the primary marker frequency is decreased. If the step marker is on a saved trace and you go outside the displayed trace, execution error message 120 will be issued.

If STEP has not been set, MSTEP will set STEP to the absolute value of the center frequency if in the Tune CF mode, to the absolute value of delta marker frequency if delta markers are on and in the Tune Marker mode, or to the absolute value of the primary marker frequency if delta markers are off and in the Tune Marker mode.

There is no MSTEP query.

PSTEP (plus step) command

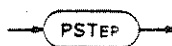

The PSTEP command increases the center frequency, if you are in the tune frequency mode, by the value set in the STEP command, if possible. If you are in the tune marker mode, the primary marker frequency is increased. If the step marker is on a saved trace and you go outside the displayed trace, execution error message 120 will be issued.

If STEP has not been set, PSTEP will set STEP to the absolute value of the center frequency if in the Tune CF mode, to the absolute value of delta marker frequency if delta markers are on and in the Tune Marker mode, or to the absolute value of the primary marker frequency if delta markers are off and in the Tune Marker mode.

There is no PSTEP query.

STSTOP (start-stop sweep) command

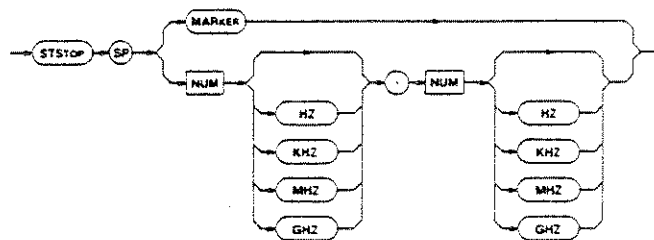

MARKER — The FREQ and SPAN commands are set so that the instrument sweeps over the frequency range delimited by the markers. The lowest frequency marker sets the start frequency, and the highest frequency marker sets the stop frequency.

NUM, NUM — The starting frequency of the display is set to the first NUM and the ending frequency is set to the second NUM. Execution error message 28 is issued if the second NUM is less than the first NUM.

Examples — STS MARKER
 STSTOP 10MHZ,130MHZ
 STS 100000HZ,66MHZ

Range — Both start and stop frequency are limited to the current band.

Power-up value — Standard instrument: start frequency, 0 MHz; stop frequency, 4.205 GHz.
 Option 01 version instrument: start frequency, 0 MHz; stop frequency, 1.805 GHz.

Interaction — Marker execution error message 123 is issued if the STSTOP MARKER command is given when MARKER is not set to DELTA.

STSTOP (start-stop sweep) query



Response to STSTOP query



The response is the present start and stop frequency (in that order), whether the values were entered as start-stop frequencies or result from the combination of a center frequency and span.

DELFR (delta-frequency) command

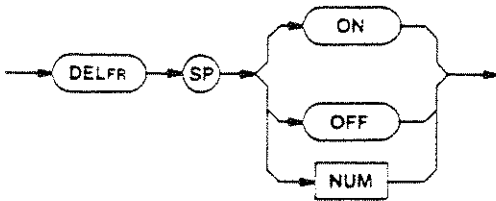

ON — The delta-frequency function is turned on. As the frequency is changed, the crt center frequency readout indicates relative frequency rather than absolute frequency. Only the readout operates differently; **FREQ** and **FREQ?** response still refer to absolute frequency. The resolution of the readout will be the lesser of the current readout resolution and the readout resolution when **DELFR** was turned on.

OFF — The delta-frequency function is turned off.

Power-up value — Off.

DELFR (delta-frequency) query



Response to DELFR query

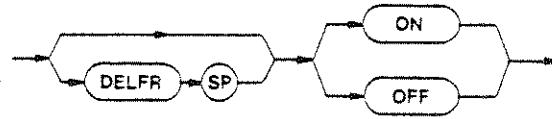

DEGAUS (degauss tuning coils) command

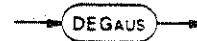

A current is momentarily turned off to remove residual magnetism in the 1st LO and preselector tuning coils. This improves preselector tracking amplitude accuracy when the preselector is not **PEAK'd** at each frequency. This function is performed automatically by the spectrum analyzer when **FRQRNG** is changed and when **CENTER/MARKER FREQUENCY** is changed by more than 1 GHz and the span is reduced from >100 MHz to <100 MHz. **DEGAUS** only functions when using the preselector in Option 01 instruments.

There is no **DEGAUS** query.

IMPED (impedance) command (Option 07 only)

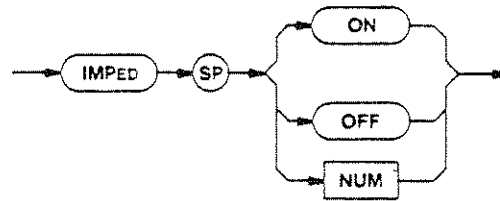

ON — The 75 Ω input is used.

OFF — The 50 Ω input is used.

Power-up value — Off.

IMPED (impedance) query (Option 07 only)

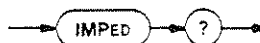

Response to IMPED query (Option 07 only)

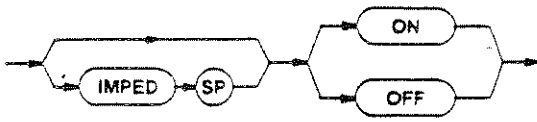

FREQUENCY SPAN AND RESOLUTION

The commands in this group control the frequency span (SPAN), the zero span mode (ZEROSP), the max span mode (MXSPN) and the resolution (RESBW and ARES) of the display. Also, true signals can be distinguished from spurious frequency conversion products (IDENT).

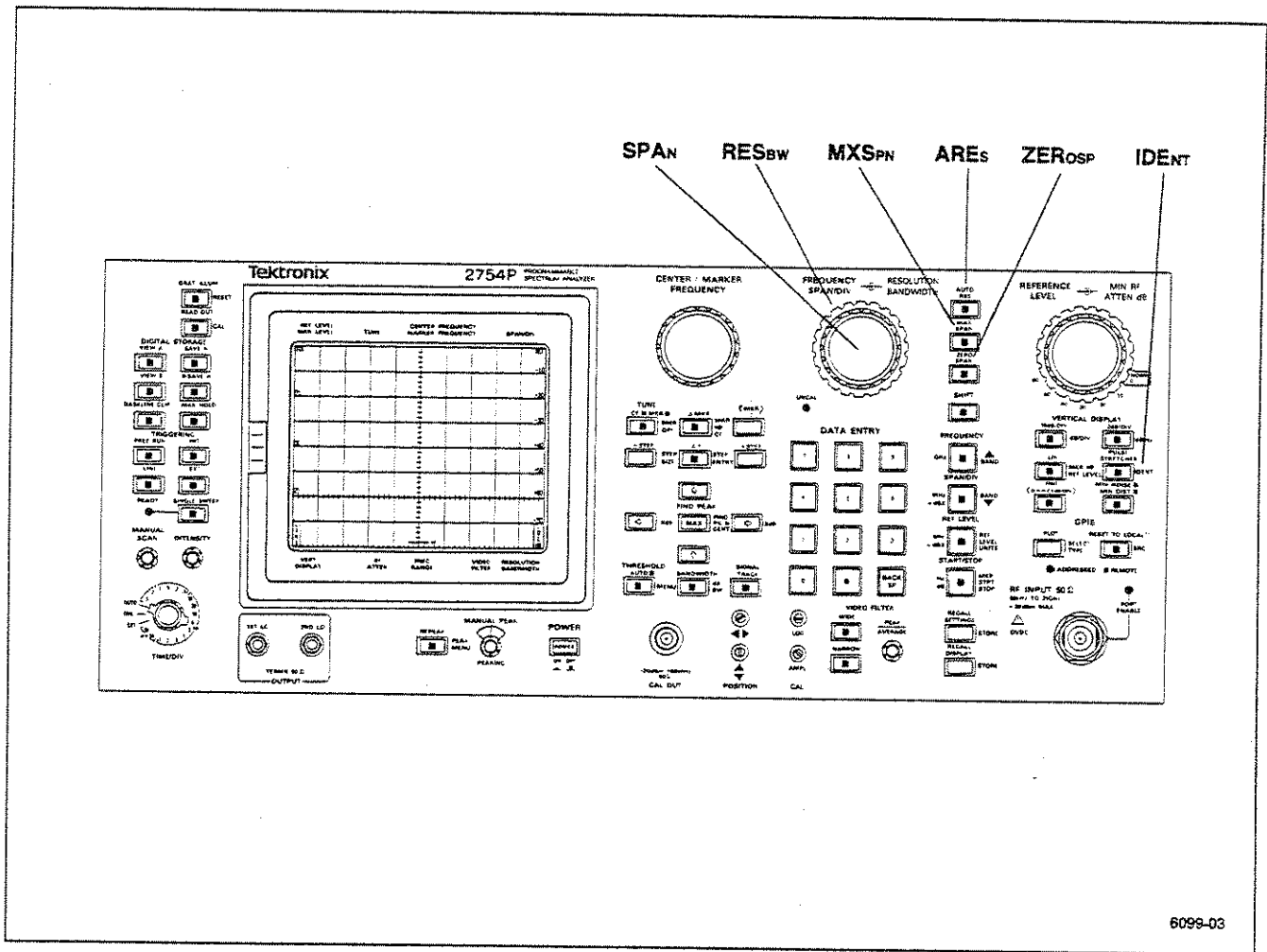
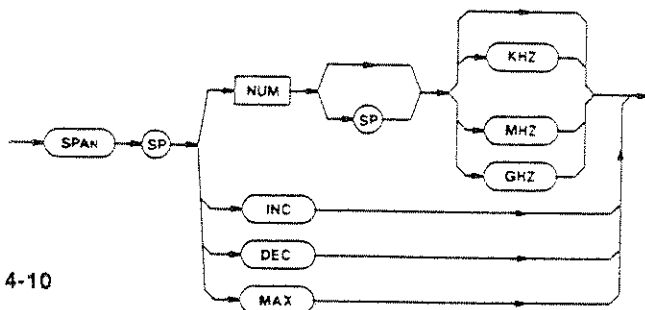

Figure 4-2. Front-panel Frequency Span and Resolution commands.

SPAN (frequency span/division) command



NUM — The span/division is selected. The value of the argument is rounded to two significant digits. Zero converts the spectrum analyzer to the time domain; in zero-span mode, the spectrum analyzer displays signals within its bandpass (RESBW) about its center frequency (FREQ). If the number is too large (refer to Table 4-2), execution warning message 50 is issued, and the spectrum analyzer defaults to MAX. If the number is too small, execution warning message 111 is issued, and the spectrum analyzer defaults to the minimum span.

INC — The next larger span/division is selected in the front-panel 1-2-5 sequence, if possible.

DEC — The next smaller span/division is selected in the front-panel 1-2-5 sequence, if possible.

MAX — The entire frequency range of the present band is swept.

Examples — SPA 200
 SPAN 50KHZ
 SPA 100 MHZ
 SPAN DEC

Power-up value — Maximum.

Interaction — Changing the SPAN setting turns ZEROSP OFF and MXSPN OFF.

Table 4-2
FREQUENCY SPAN/DIV RANGES

Band	Narrowest Span Available	Widest Span Available
1 (50 kHz–4.2 GHz)	200 Hz	410 MHz
1 (50 kHz–1.8 GHz)	100 MHz (Option 01)	170 MHz (Option 01)
2 (1.7–5.5 GHz)	200 Hz	370 MHz
3 (3.0–7.1 GHz)	200 Hz	400 MHz
4 (5.4–18.0 GHz)	200 Hz	1.2 GHz
5 (15–21 GHz)	200 Hz	590 MHz

SPAN (frequency span/division) query



Response to SPAN query

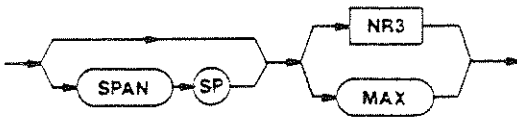

ZEROSP (zero-span mode) command

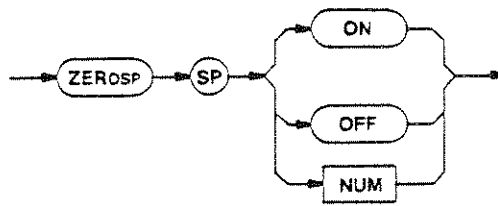

ON — The spectrum analyzer is converted to a time domain mode with the frequency sweep defeated. Crt readout shifts to the TIME/DIV mode on the horizontal axis instead of FREQ SPAN/DIV. The previous FREQ SPAN/DIV is saved, and it is restored when ZEROSP is turned OFF.

OFF — ZEROSP is cancelled, leaving the FREQ SPAN/DIV at the value previously selected.

Power-up value — Off.

Interaction — Changing the SPAN setting turns ZEROSP OFF.

ZEROSP (zero span mode) query



Response to ZEROSP query

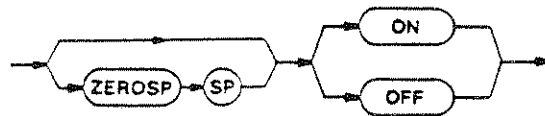

The response is the current zero span condition.

NOTE

It may be preferable to use ZEROSP rather than SPAN 0. When ZEROSP is ON, the front-panel ZERO SPAN indicator is lit so you have a positive indication that the zero span mode is set, in addition to the crt readout. When ZEROSP is turned off, the previous SPAN/DIV setting is restored.

MXSPN (max-span mode) command

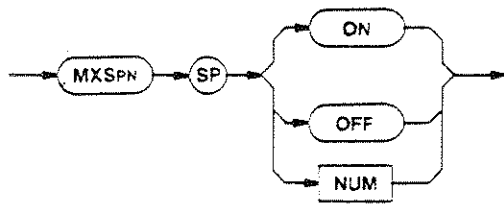

ON — The spectrum analyzer sweeps the entire range of frequencies of the current band. **FREQ** no longer corresponds to center frequency; it now corresponds to the frequency at the tunable dot above the display or the marker on the display. The previous **FREQ SPAN/DIV** is saved, and it is restored when **MXSPN** is **OFF**.

OFF — **MXSPN** is cancelled, leaving the **FREQ SPAN/DIV** at the value previously selected.

Power-up value — Off.

Interaction — Changing **SPAN** setting turns **MXSPN** **OFF**.

MXSPN (max-span mode) query



Response to MXSPN query

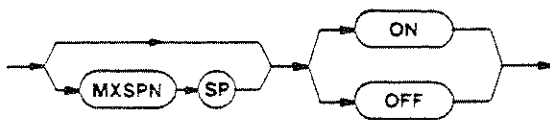

The response is the current **MXSPN** condition.

NOTE

It may be preferable to use **MXSPN** rather than **SPAN MAX**. When **MXSPN** is **ON**, the front-panel **MAX SPAN** indicator is lit so you have a positive indication that the maximum span mode is set, in addition to the crt readout. When **MXSPN** is turned off, the previous **FREQUENCY SPAN/DIV** setting is restored.

RESBW (resolution bandwidth) command

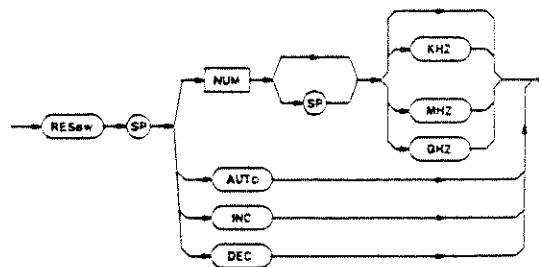

NUM — The nearest available resolution bandwidth is selected; numbers between bandwidths that can be selected from the front panel are rounded. Positive numbers above or below the range of bandwidth steps are rounded to the nearest step (execution error message 32 is issued if the argument is beyond the normal range). Zero and negative numbers cause an error. Values are rounded to a single significant digit. If the number is above the breakpoint, the next higher bandwidth step is selected. If the number is equal-to-or-less-than the breakpoint, the next lower step is selected.

Table 4-3

RESOLUTION BANDWIDTH SELECTION

Value ^a	Selects
317 Hz–3.16 kHz	1 kHz
3.17 kHz–31.6 kHz	10 kHz
31.7 kHz–316 kHz	100 kHz (Non Option 07)
31.7 kHz–316 kHz	300 kHz (Option 07 Only)
317 kHz–3.16 MHz	1 MHz

^aValues outside the ranges listed cause execution error message 32 to be issued.

AUTO — Auto resolution is selected (equivalent to ARES ON).

INC — The next larger step is selected (if possible).

DEC — The next smaller step is selected (if possible).

Examples — RES 100 kHz
RESBW 1KHZ
RES 1.5 MHz
RESBW INC

Range — See Table 4-3.

Power-up value — 1 MHz.

Interaction — Any argument except AUTO cancels ARES ON. Reducing resolution bandwidth may require a slower sweep speed (TIME) to maintain a calibrated display unless TIME/DIV is set to AUTO.

RESBW (resolution bandwidth) query



Response to RESBW query

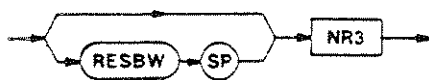

The response to the SET query includes the AUTO argument (see SET? under Instrument Parameters in Section 8 of this manual); because, in AUTO, the spectrum analyzer can determine the bandwidth.

ARES (automatic resolution bandwidth) command

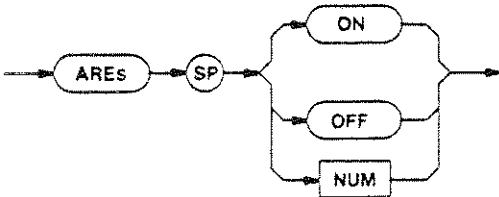

ON — The current span is matched with an appropriate resolution bandwidth that maintains calibrated performance for the current sweep speed, if possible. If automatic sweep speed is active, an appropriate resolution bandwidth is selected that changes the sweep speed to the fastest sweep that allows calibrated performance. ARES ON is cancelled by any RESBW command except RESBW AUTO.

OFF — ARES ON is cancelled, leaving the resolution bandwidth at the current value.

Power-up value — On.

Interaction — ARES OFF also cancels RESBW AUTO.

ARES (automatic resolution bandwidth) query



Response to ARES query

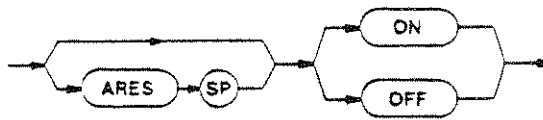

ARES is not included in the response to the SET query, because it is included in the RESBW? response.

IDENT (identify) command

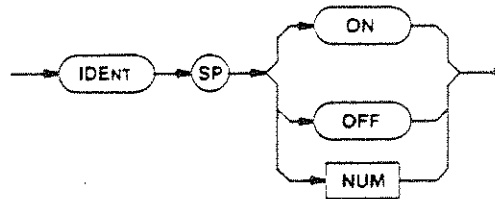

ON — The identify function is turned on. Spurious conversion products are shifted horizontally by >1 division on alternate traces. The trace is also offset vertically on alternate sweeps so true signals stand out.

OFF — The identify function is turned off.

Power-up value — Off.

Interaction — The span must be 50 kHz/div or less for the identify function to operate. The SIGSWP commands cause alternating normal and vertically offset sweeps; the first sweep is normal, the next offset, and so on. If SGTRAK is on, execution error message 101 is issued if IDENT is ON and the command is not executed.

IDENT (identify) query

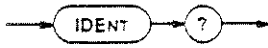

Response to IDENT query

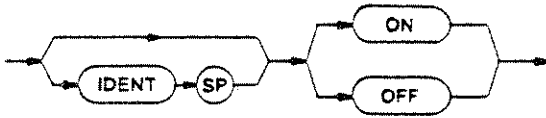

VERTICAL DISPLAY AND REFERENCE LEVEL

The commands in this group control the vertical scale factor (VRTDSP) and reference level (REFLVL and FINE) of the display, and select the reference level units (RLUNIT). The gain distribution (combination of RF attenuation and IF gain) is automatically set according to the reference level mode (RLMODE); this takes into account the least amount of RF attenuation (MINATT) allowed or maximum power (MAXPWR) expected, and the current RF attenuation is requested (RFATT?). The signal can be maximized (PEAK). The pulse stretcher (PLSTR) stretches narrow or pulsed signals for acquisition and display. If a video filter (VIDFLT) is switched in, noise in the display is reduced. Calibration of the IF filters for frequency and amplitude is possible from the front panel (CAL and ENCAL).

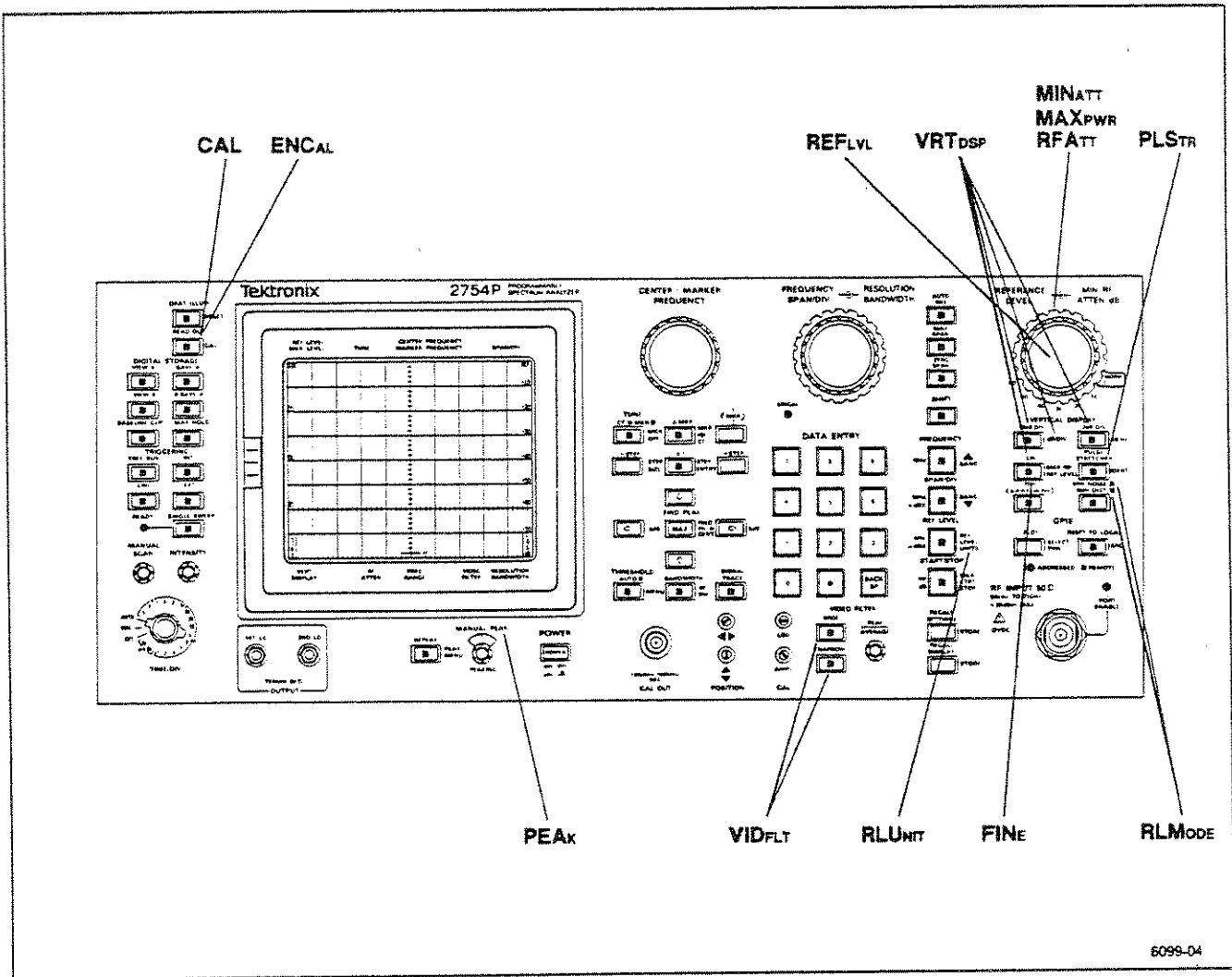
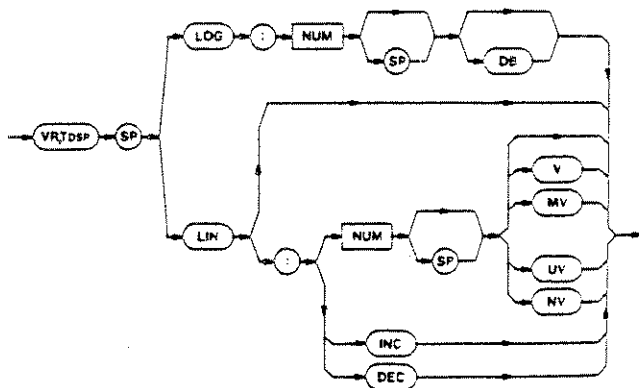
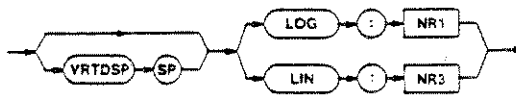

Figure 4-3. Front-panel Vertical Display and Reference Level commands.

VRTDSP (vertical display) command



Response to VRTDSP query



REFLVL (reference level) command

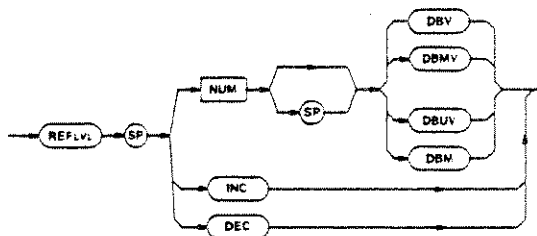

LOG — The display is scaled to the dB/division specified by integers in the range 1 to 15; non-integers are rounded. VRTDSP LOG values outside this range cause execution error message 36 to be issued.

LIN — The display is scaled in volts/division. NUM is adjusted to the volts equivalent of the nearest 1 dB/div. If NUM is omitted, the display is scaled to leave the reference level at its current value; $V/D = 1/8^*$ (volts equivalent of REFLVL). INC or DEC changes the scale factor to the next step in the 1-2-5 volts/division sequence, if possible, when FINE is OFF. When FINE is ON, the next step is determined by the 1 dB change in REFLVL that INC or DEC causes; the new scale factor is $1/8^*$ (volts equivalent of REFLVL). Out-of-range values cause the spectrum analyzer to report execution error message 35.

Examples — VRT LOG:3
 VRTDSP LOG:2DB
 VRT LOG:1 DB
 VRTDSP LIN
 VRT LIN:2
 VRTDSP LIN:1.5MV
 VRT LIN:75 NV
 VRTDSP LIN:INC

Power-up value — LOG:10 dB/division.

Interaction — The selection of 1, 2, 3, or 4 dB/div with FINE ON causes the spectrum analyzer to enter a delta-amplitude mode. See FINE for a discussion of this mode.

VRTDSP (vertical display) query

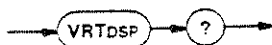

NOTE

To ensure the correct response, all of the letters in each of the unit mnemonics for the REFLVL command must be entered; not just the first three letters as required for other mnemonics.

NUM — The spectrum analyzer sets the reference level to the nearest dBm step for a log vertical display (except in the Delta Amplitude mode), and to the nearest dBm step for a linear vertical display. The Delta Amplitude mode allows 0.25 dB resolution; the argument to the REFLVL command is always the absolute reference level, not an offset to the present reference level, though the crt readout shows relative amplitude in the Delta Amplitude mode only. If the number selected is out of range, execution error message 34 is issued. If no units are specified, the spectrum analyzer assumes the current units.

INC or DEC — The reference level is stepped up or down once. The step value is determined by the value of the VRTDSP scale factor and FINE selection (refer to Table 4-4).

Examples — REF -200DBV
 REFLVL -10 DBMV
 REF -30DB μ V
 REFLVL -25 DBM
 REF INC

Power-up value — +30 dBm.

Table 4-4
REFERENCE LEVEL SETTINGS

VERTDSP Scale Factor	FINE ON	FINE OFF
15 dB	1 dB	15 dB
14 dB	1 dB	14 dB
13 dB	1 dB	13 dB
12 dB	1 dB	12 dB
11 dB	1 dB	11 dB
10 dB	1 dB	10 dB
9 dB	1 dB	9 dB
8 dB	1 dB	8 dB
7 dB	1 dB	7 dB
6 dB	1 dB	6 dB
5 dB	1 dB	5 dB
4 dB	Delta-Amplitude mode (0.25 dB)	4 dB
3 dB	Delta-Amplitude mode (0.25 dB)	3 dB
2 dB	Delta-Amplitude mode (0.25 dB)	1 dB
1 dB	Delta-Amplitude mode (0.25 dB)	1 dB
LIN	1 dB	Either 6 dB or 8 dB (varies to match 1-2-5 volts/div sequence)

Power-up value — +30 dBm.

REFLVL (reference level) query

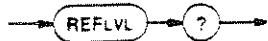

Response to REFLVL query

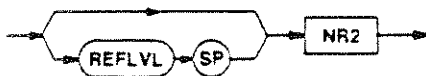

Only the number value will be returned; the units will not be indicated (the number will be returned in the current units). The value returned is the absolute reference level, whether or not in the Delta Amplitude mode.

RLUNIT (reference level units) command

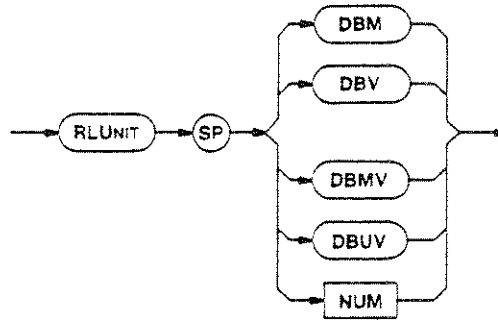

NOTE

To ensure the correct response, all of the letters in each of the unit mnemonics for the RLUNIT command must be entered; not just the first three letters as required for most other mnemonics.

DBM — The reference level (REFLVL) units are set to dBm.

DBV — The reference level (REFLVL) units are set to dBV

DBmV — The reference level (REFLVL) units are set to dBmV.

DB μ V — The reference level (REFLVL) units are set to dB μ V.

- NUM — 0 = dBm
- 1 = dBV
- 2 = dBmV
- 3 = dB μ V

Power-up value — dBm.

Interaction — In instruments with Option 07 installed, dBmV is automatically selected when the 75- Ω input is chosen, and dBm is automatically selected when the 50- Ω input is chosen. The units designator can be overridden once the input selection has been made.

RLUNIT (reference level units) query

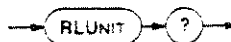

Response to RLUNIT query

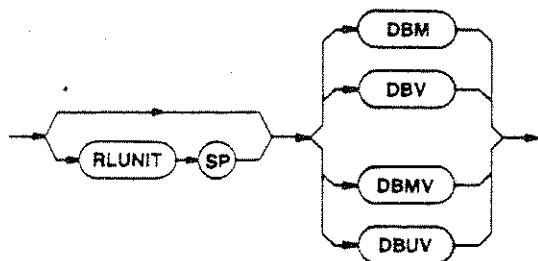

CAL (cal) command

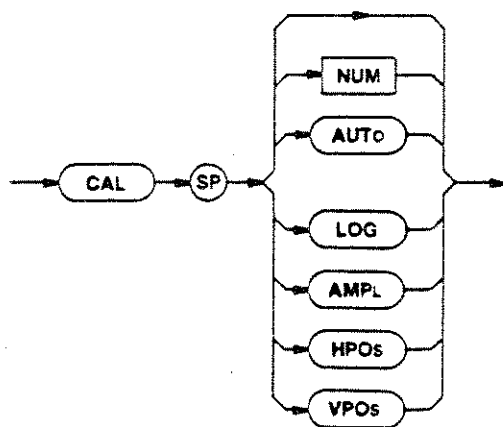

NOTE

The spectrum analyzer assumes a 100 MHz calibrator is connected during CAL AUTO, CAL AMPL, and CAL LOG operation.

- NUM—0 = AUTO
- 1 = LOG
- 2 = AMPL
- 3 = HPOS
- 4 = VPOS

CAL (without arguments) or CAL AUTO — The resolution bandwidth filter frequencies are calibrated with respect to 10 MHz and levels relative to the 1 MHz filter level (within a range of +2, -4 dB) and measure filter bandwidths used in dB/Hz normalization. During operation, the word MEASURING appears on the screen.

CAL LOG — The instrument is set up so you can set the front-panel CAL LOG adjustment. CAL LOG has an indefinite execution time and will operate until either a device clear (DCL) is received from the GPIB port or the spectrum analyzer is returned to local control from the instrument front panel. An instruction message appears on the screen.

CAL AMPL — The instrument is set up so you can set the front-panel CAL AMPL adjustment. CAL AMPL has an indefinite execution time and will operate until either a device clear (DCL) is received from the GPIB port or the spectrum analyzer is returned to local control from the instrument front panel. An instruction message appears on the screen.

CAL HPOS — The instrument is set up so you can set the front-panel horizontal POSITION control. CAL HPOS has an indefinite execution time and will operate until either a device clear (DCL) is received from the GPIB port or the spectrum analyzer is returned to local control from the instrument front panel. An instruction message appears on the screen.

CAL VPOS — The instrument is set up so you can set the front-panel vertical POSITION control. CAL VPOS has an indefinite execution time and will operate until either a device clear (DCL) is received from the GPIB port or the spectrum analyzer is returned to local control from the instrument front panel. An instruction message appears on the screen.

Power-up value — Off.

CAL (cal) query



Response to CAL query

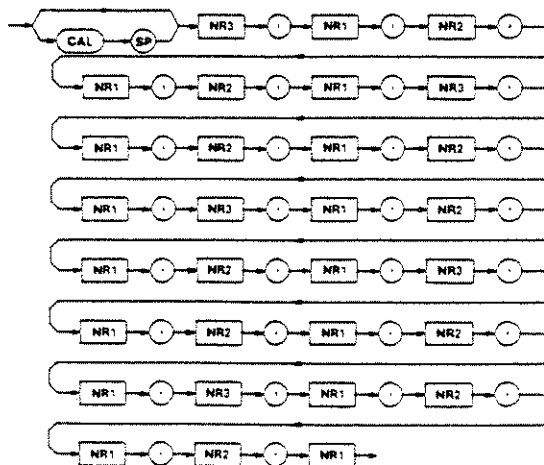

In the CAL? response, the same data is given in succession for the 1 MHz, 100 kHz (300 kHz for Option 07 instruments), 10 kHz, and 1 kHz filters (in that order). The data given for each filter is the following.

- frequency error
- frequency calibration code
- level error
- level calibration code
- noise bandwidth factor
- bandwidth calibration code

The frequency error is the difference between the measured filter frequency and 10 MHz, expressed in Hz. The level error is the difference between the measured filter level and the measured level of the 1 MHz filter, expressed in dB. The noise bandwidth is expressed as the dB correction used to normalize the filter's output to 1 Hz.

Use Table 4-5 to decode the calibration code numbers.

Table 4-5
CALIBRATION CODES

Code Number	Description
0	A calibration value for this item has not been found (i.e., this filter has never been calibrated before).
1	A calibration value for this item has been found, but the most recent calibration attempt failed (the last previously-good value is used).
2	The value recorded for this item is the limit value (i.e., the best it could do). The actual required correction would exceed the limit (+2, -4 dB), so this item is not calibrated. (This applies to amplitude calibration only.)
3	A calibration value for this item has been found, but the most recent calibration attempt failed (the last previously-good value is used). The value recorded for this item is the limit value (i.e., the best it could do). The actual required correction would exceed the limit (+2, -4 dB), so this item is not calibrated. (This applies to amplitude calibration only.)
4	The last calibration attempt for this item succeeded.
5	This filter is the reference for level calibration. (this applies to amplitude calibration only.)

ENCAL (enable calibration factors) command

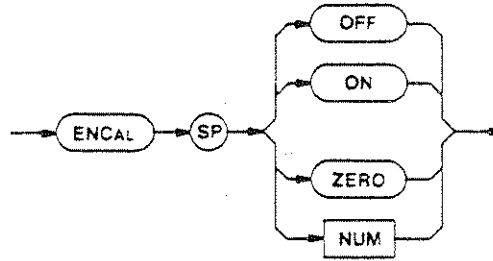

OFF — The filter's amplitude and frequency are not corrected, and the nominal noise bandwidth is used.

ON — The calibration factors are used internally to correct frequency level errors and noise bandwidth in the filters.

ZERO — Set calibration factors to 0; this does not affect OFF/ON status.

NUM — 0 = OFF
1 = ON
2 = ZERO

Power-up Value — On.

ENCAL (enable calibration factors) query



Response to ENCAL query

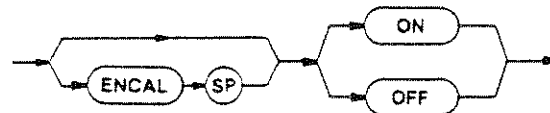

FINE (fine reference level steps) command

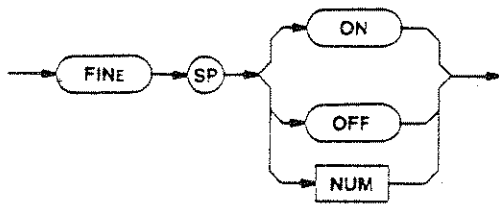

ON — Small steps are selected for the INC or DEC arguments in the reference level command (see REFLVL for details). With vertical scale factors of 1, 2, 3, and 4 dB/div, FINE ON selects the delta-amplitude mode.

Delta-Amplitude Mode — The Delta Amplitude mode is active when both FINE reference level steps and a scale factor of 4 dB/div or less are selected. In this mode, the crt VERT DISPLAY readout initializes to 0.00 dB. Changes in reference level are displayed as the difference between the initial level and the new level, not the absolute reference level. This readout is available with UPDO?. REFLVL? returns the absolute reference level. The initial gain distribution (RF attenuation and IF gain) is not disturbed; changes in reference level are created by an offset in the display. This allows signals to be compared with inherently higher relative accuracy over a range of at least 0 dB to -36 dB from the initial level, without an overload to the spectrum analyzer input.

OFF — Normal steps are restored for reference level changes, which cancels the Delta Amplitude mode (if active).

Power-up value — Off.

Interaction — This command, along with VRTDSP, controls the spectrum analyzer response to REFLVL INC or DEC.

FINE (fine reference level steps) query



Response to FINE query

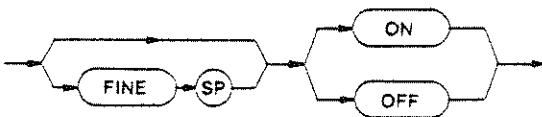

RLMODE (reference level mode) command

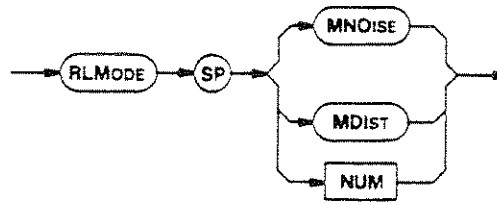

MNOISE — The spectrum analyzer is requested to assign gain distribution with minimum RF attenuation for a given reference level. Generally, this yields 10 dB less RF attenuation than the MDIST argument and results in less displayed noise (but may increase distortion).

MDIST — Normal RF attenuation is requested for a given reference level. Generally, this yields 10 dB more RF attenuation than the MNOISE argument and results in lower signal levels in the analyzer, hence less distortion.

NUM — 0 = MNOISE
1 = MDIST

Power-up value — MDIST

Interaction — This command affects the gain distribution obtained with the REFLVL command (see also MINATT and MAXPWR).

RLMODE (reference level mode) query



Response to RLMODE query

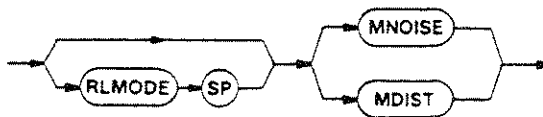

PEAK (peaking) command (Option 01 only)

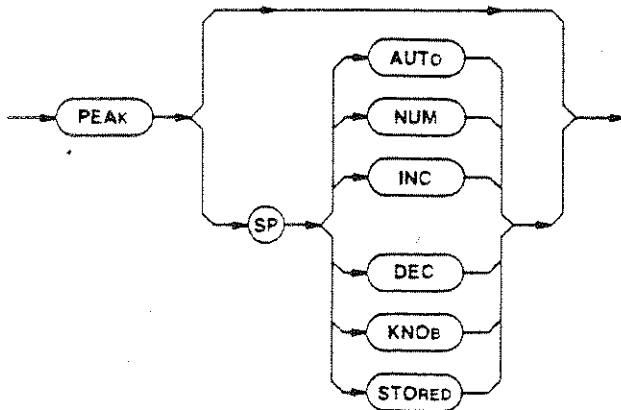

AUTO — During several sweeps, the spectrum analyzer automatically tunes the PEAK control to peak the largest signal in a window around the display data point. The peak code consists of numbers at 500 MHz intervals when using the preselector. These numbers are stored in memory. If a signal is not found within the window, the previously-acquired peaking code stored in memory is used. End-of-sweep interrupts are not issued and the TRIGGERING, TIME/DIVISION, and MAX HOLD values may be changed by the spectrum analyzer while PEAK is active. The previous values are restored when PEAK AUTO is through. Although this command uses digital storage, it does not overwrite the A portion if SAVEA is ON.

The PEAK command without an argument is the same as PEAK AUTO.

NUM — The number is stored in memory. Non-integers or numbers outside the range are rounded to the nearest integer in the range; no warning is issued. This affects the current peaking number only.

Range — 0 to 1023.

INC or DEC — The value of PEAK is changed ± 1 from its current value, which is stored in memory, and the new value is stored in memory.

KNOB — The front-panel MANUAL PEAK control is active. You can manually peak the spectrum analyzer's response from the front panel. All other arguments switch to internal peaking and cancel KNOB.

STORED — The value stored in memory for the present band is used.

MARKER — PEAK MARKER acts the same as PEAK AUTO; except, PEAK MARKER will peak ± 1 division from the marker and it will turn the marker on if off.

Examples — PEAK
PEA AUTO
PEAK 512
PEA STO

Power-up value — KNOB (MANUAL PEAK control on).

Interaction — In the standard instrument, AUTO may be used in bands 2 through 5. Under the conditions where AUTO may not be used, peaking is not used, and the stored number or knob position has no effect.

PEAK (peaking) query (Option 01 only)



Response to PEAK query (Option 01 only)

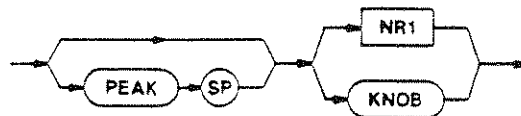

MINATT (minimum RF attenuation) command

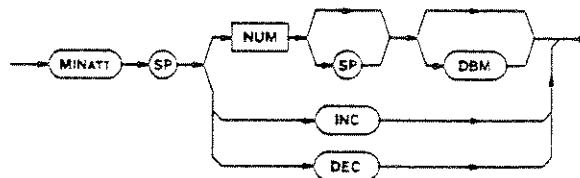

NUM — The gain distribution set by the spectrum analyzer is limited; RF attenuation may not be reduced below the attenuator step in the number argument. If NUM is not an even decade from 0 to 60, the next higher step (0, 10, 20, ... 60) is selected. If the number selected is out of range, execution error message 33 is issued.

INC or DEC — The minimum RF attenuation is changed to the next higher or lower step, if any.

Examples — MINATT 20
MIN 42 DB
MINATT INC

Range — 0 to 60.

Power-up value — MIN RF ATTEN dB control setting.

Interaction — The range of RF attenuation is limited in response to the REFLVL command, which limits the range of the REFLVL command. The previous limit set by either MINATT or MAXPWR is cancelled.

MINATT (minimum RF attenuation) query



Response to MINATT query

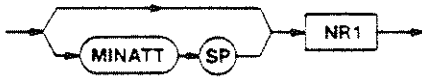

MAXPWR (maximum input power) command

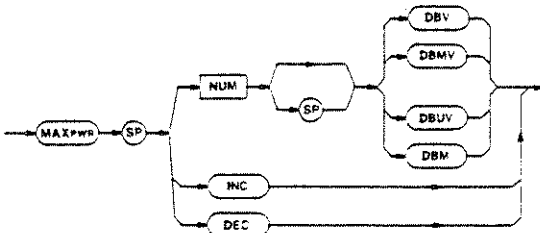

NUM — This is an input to a spectrum analyzer that protects the RF INPUT from overload at the expected maximum power level. The instrument selects a minimum RF attenuation so that the NUM signal level is reduced to -18 dBm at the 1st Mixer. (This is the spectrum analyzer's 1 dB compression point.) The maximum non-destructive power level that can be connected to the RF INPUT is +30 dBm. If no units are specified, the spectrum analyzer assumes the current units. If the number selected is out of range, execution error message 33 is issued.

NOTE

To ensure the correct response, all of the letters in each of the units mnemonics for the MAXPWR command must be entered; not just the first three letters as required for other mnemonics.

INC or DEC — The minimum RF attenuation is changed to the next higher or lower step, if any.

Examples — MAXPWR +20DBMV
 MAX 18 DBUV
 MAXPWR DEC

Interaction — The range of RF attenuation is limited in response to the REFLVL command, which limits the range of the REFLVL command. MAXPWR cancels the previous limit set by either MINATT or MAXPWR.

MAXPWR (maximum input power) query



Response to MAXPWR query

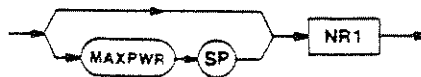

Only the number value will be returned; the units will not be indicated (the units will be the current reference level units).

RFATT (RF attenuation) query



Requests the current value of RF attenuation.

Response to RFATT query

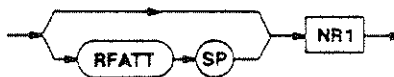

There is no RFATT command.

PLSTR (pulse stretcher) command

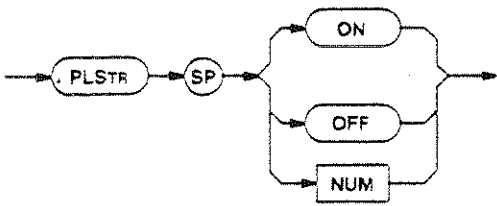

ON — The fall time of detected signals is increased so very narrow pulses in a line spectrum display can be seen. The effect is apparent for signals analyzed at resolution bandwidths that are narrow compared to the span. It may be necessary to turn on the pulse stretcher for digital storage of such signals, especially if the cursor is set high enough to average them.

Pulse stretcher may be required to view and store fast pulsed signals. For short pulses, the signal may exist for less time than is required for a point to be digitized, causing either no value or too low a value to be stored.

OFF — The pulse stretcher is turned off.

Power-up value — Off.

PLSTR (pulse stretcher) query



Response to PLSTR query

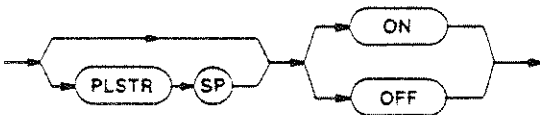

VIDFLT (video filter) command

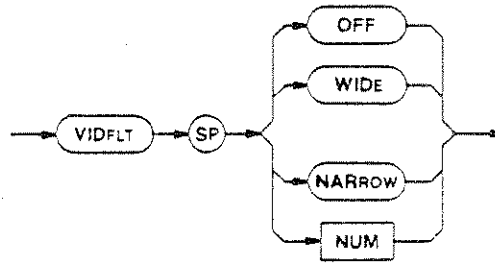

OFF — Both the wide and the narrow video filters are turned off.

WIDE — A filter is turned on in the video amplifier (after the detector) to average noise in the display. The wide filter reduces video bandwidth to about 1/30 of the selected resolution bandwidth.

NARROW — The narrow video filter reduces video bandwidth to about 1/300 of the selected resolution bandwidth.

NUM — 0 = OFF
1 = WIDE
2 = NARROW

Power-up value — Off.

Interaction — It may be necessary to reduce sweep speed (TIME) to maintain a calibrated display unless TIME is in AUTO, because the spectrum analyzer's overall bandwidth is reduced by video filtering.

VIDFLT (video filter) query

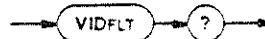

Response to VIDFLT query

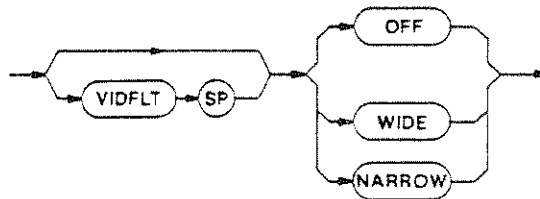

SWEEP CONTROL

Three commands control the spectrum analyzer sweep, which is used both to sweep the frequency span and the CRT display. These commands control the sweep triggering and mode (TRIG and SIGSWP) and sweep rate (TIME). Selection of TIME AUTO directs the instrument to automatically match the sweep to related spectrum analyzer parameters. Other options include manual or external analog control of the sweep.

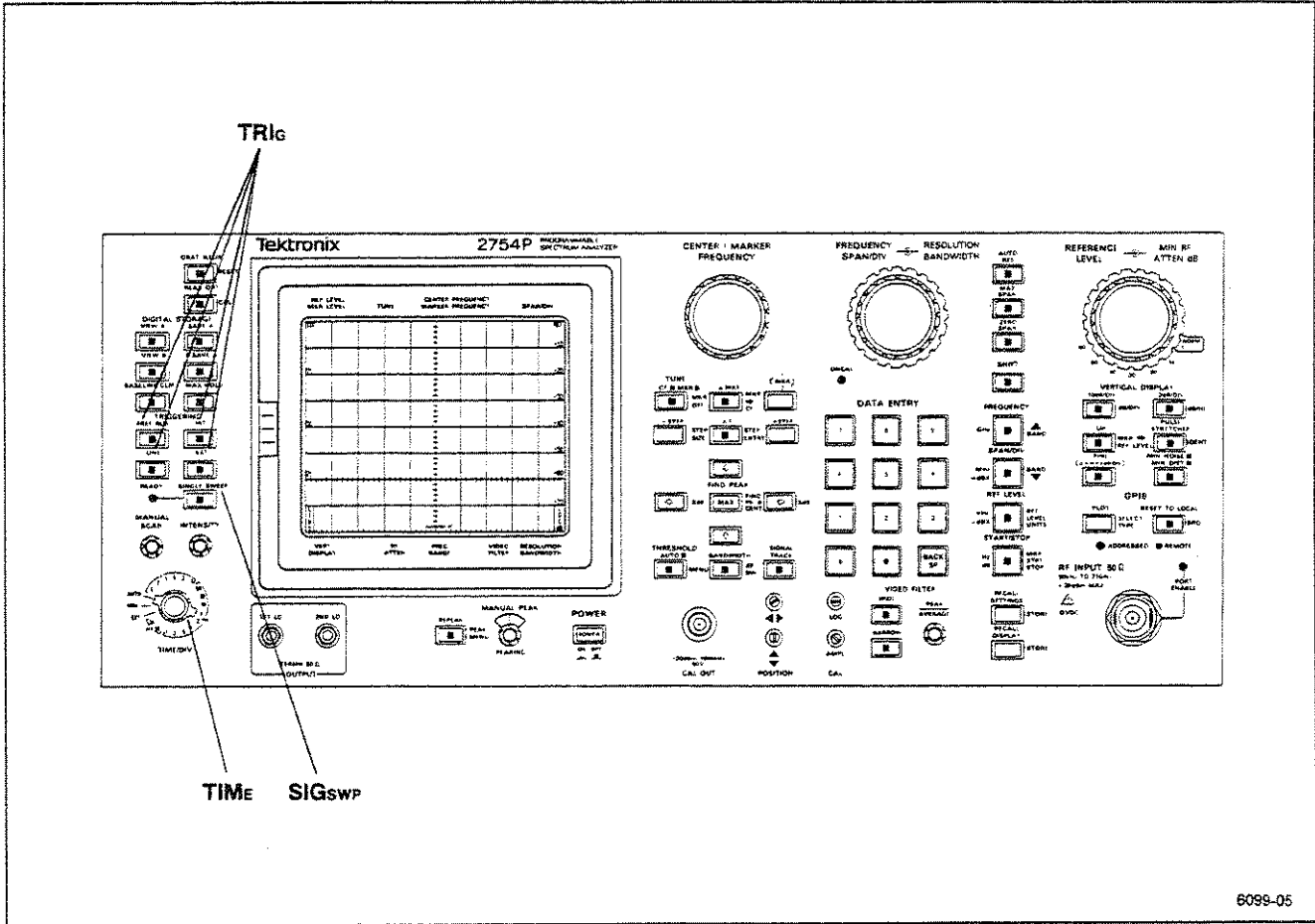
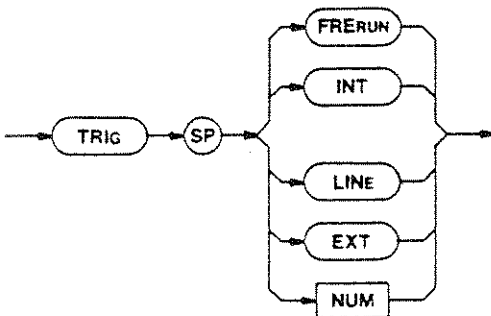

Figure 4-4. Front-panel Sweep Control commands.

TRIG (triggering) command



NOTE

The Single Sweep mode should be used under most programming conditions (see Programming Techniques in the Helps and Hints section later in this manual).

FRERUN — The spectrum analyzer sweep is allowed to run repetitively. A trigger is not required (and is ignored), so the instrument generates a sweep immediately after the hold-off period that follows the previous sweep. This is a simple and common setup used to acquire a spectrum for manual operation.

INT — The spectrum analyzer generates a sweep only when it is triggered by an input signal. A signal amplitude of at least 2 divisions is required and must occur after the hold-off period that follows the previous sweep. This sweep mode is often used to examine time-domain signals in the zero-span mode (ZEROSP).

LINE — The power line input is selected as the trigger signal (useful in both the frequency domain and time domain modes for signals with components related to the power line frequency).

EXT — The sweep is triggered for pulsed signals by a signal with an amplitude of at least +1.0 V peak connected to HORIZ|TRIG (EXT IN) on the rear panel.

- NUM** — 0 = FRERUN
 1 = INT
 2 = LINE
 3 = EXT

Power-up value — Free-run.

Interaction — The signal frequency required for internal trigger is related to the center frequency. In the frequency domain mode, the required frequency corresponds to 1/2 division to the left of the left graticule edge; in the time domain mode, the required frequency is the center frequency. In the frequency domain mode, the required frequency must be within the selected band (e.g., 1.7 GHz to 5.5 GHz in band 2).

TRIG (triggering) query

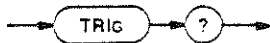

Response to TRIG query

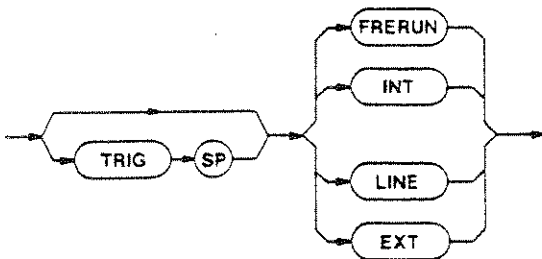

SIGSWP (single-sweep) command

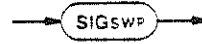

On the first SIGSWP command, the spectrum analyzer enters the single-sweep mode, which stops the current sweep. Once in the single-sweep mode, this command arms the sweep and lights the front-panel READY light, which remains lit for the duration of the sweep. The spectrum analyzer makes a single sweep of the selected spectrum when the conditions determined by the TRIG command are met. Refer to Programming Techniques in the Helps and Hints section later in this manual.

Power-up value — Off.

Interaction — Any TRIG command cancels the single-sweep mode.

SIGSWP (single-sweep) query



Response to SIGSWP query

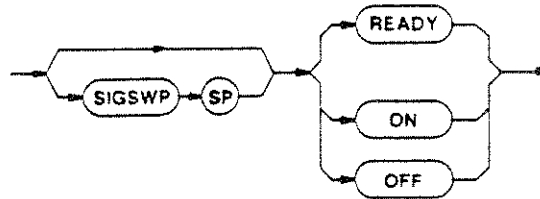

The response to the SET query is omitted if single-sweep is not active (see SET? under Instrument Parameters in Section 8 of this manual).

TIME (time/div) command

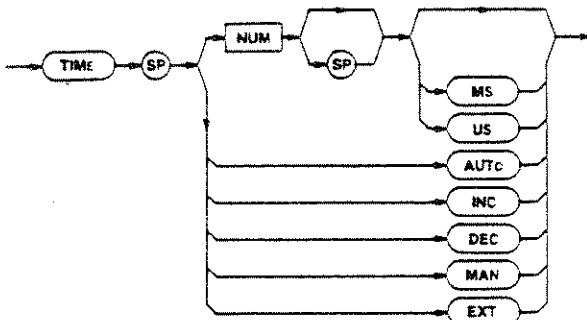

Response to TIME query

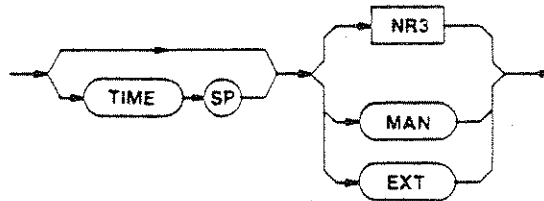

The SET? response includes AUTO as a possible argument (see SET? under Instrument Parameters in Section 8 of this manual).

NUM — 1-2-5 sequence in the range 20E-6 to 10. Numbers not in this sequence are rounded to the nearest step. If the number selected is out of range, execution error message 37 is issued.

AUTO — The spectrum analyzer is requested to select the fastest sweep allowed for calibrated response.

INC or DEC — The sweep rate is changed ± 1 in the sequence, if possible.

MAN — The sweep is coupled to the MANUAL SCAN control so you can manually scan the spectrum. As the control is turned, the horizontal position of the crt beam and the spectrum analyzer front-end tuning are varied from the center of the sweep and the center of the selected spectrum.

EXT — The sweep is coupled to HORIZ/TRIG (EXT IN) on the rear panel. The horizontal position of the crt beam and the spectrum analyzer front-end tuning are varied by an external signal. A signal in the range 0 to +10 V scans the spectrum.

Examples — TIME 1
 TIM 10 MS
 TIME MAN

Power-up value — TIME/DIV control setting.

Interaction — Too fast a sweep speed for a given resolution bandwidth will uncalibrate the display. For digital storage to properly acquire spectrum data, 10 ms/div is the maximum usable sweep rate.

TIME (time/div) query



DIGITAL STORAGE

These commands control the digital storage functions of display (AVIEW, BVIEW), updating (SAVEA), comparison (BMINA), display storage (DSTORE), display recall (DRECAL), and digitizer control (MXHLD, CRSOR).

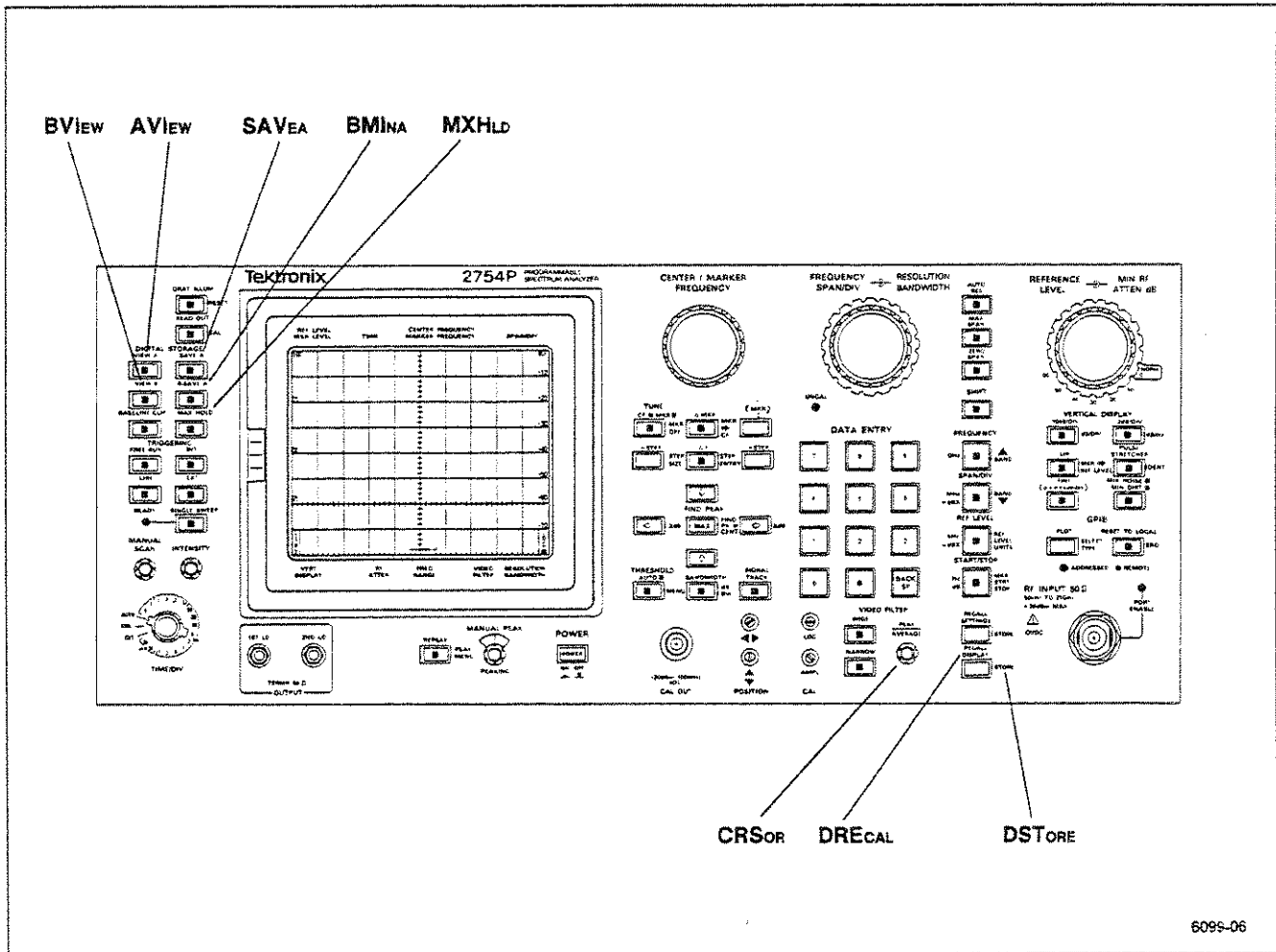
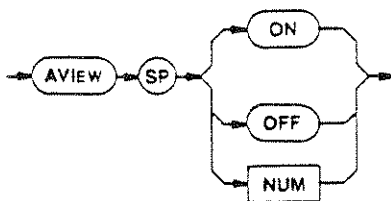

Figure 4-5. Front-panel Digital Storage commands.

AVIEW (A waveform display) command



ON — The A waveform is displayed on the crt. The waveforms are independent and may be displayed together or separately; however, both waveforms will be displayed if either AVIEW or BVIEW is on and SAVEA is off.

OFF — The display of the A waveform is turned off. (See the ON description for operation with SAVE off.) If both AVIEW and BVIEW are turned off, the input signal is displayed in real time.

Power-up value — On.

Interaction — While SAVEA is ON, any updating of the trace display in A is halted.

AVIEW (A waveform display) query



Response to AVIEW query

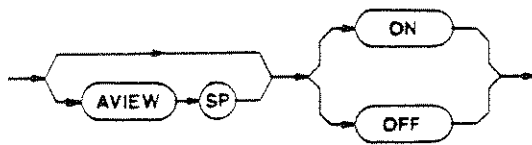

BVIEW (B waveform display) command

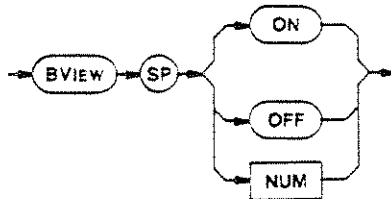

ON — The B waveform is displayed on the crt. The waveforms are independent and may be displayed together or separately; however, both waveforms will be displayed if either AVIEW or BVIEW is on and SAVEA is off.

OFF — The display of the B waveform is turned off. (See the ON description for operation with SAVE off.) If both AVIEW and BVIEW are turned off, the input signal is displayed in real time.

Power-up value — On.

BVIEW (B waveform display) query



Response to BVIEW query

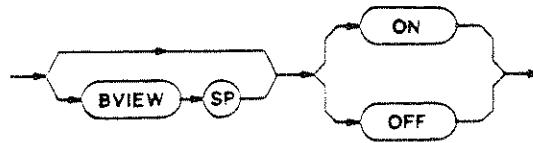

SAVEA (save A waveform) command

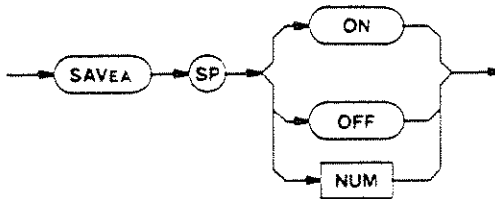

ON — The A waveform updating is stopped and the current contents are saved. This allows comparison with the B waveform, which is continuously updated. The information in the crt readout is saved, and will be displayed instead of the current spectrum analyzer settings if only AVIEW is on (both BVIEW and BMINA off).

OFF — The A waveform updating is resumed.

Power-up value — Off.

Interaction — BMINA ON turns SAVEA ON. SAVEA OFF turns BMINA OFF.

SAVEA (save A waveform) query



Response to SAVEA query

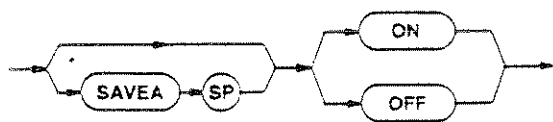

BMINA (B-A waveform display) command

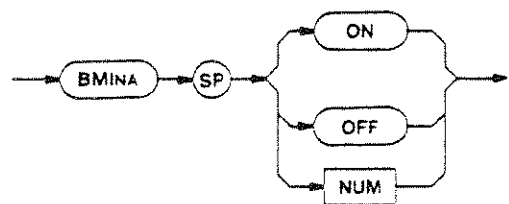

ON — The spectrum analyzer turns on SAVEA if it is off and then turns on a display of the difference between the A waveform and the B waveform, which is continuously updated. The difference trace baseline is normally set at graticule center, but may be varied with an internal switch (refer any changes to qualified service personnel; information is available in the Service Manual, Volume 1).

OFF — The difference display is turned off.

Power-up value — Off.

Interaction — BMINA ON turns SAVEA ON. SAVEA OFF turns BMINA OFF.

BMINA (B-A waveform display) query

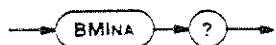

Response to BMINA query

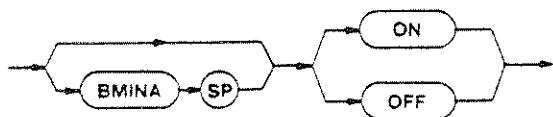

DSTORE (store display) command

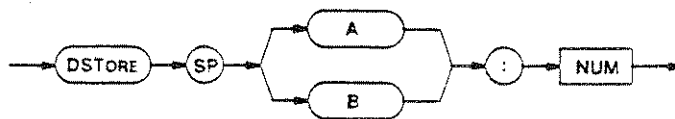

A — The A waveform is stored in the memory location indicated by NUM. If the number requested is out of the range limit, execution error message 47 is issued.

B — The B waveform is stored in the memory location indicated by NUM. If the number requested is out of the range limit, execution error message 47 is issued.

The readout and markers associated with the display are stored with the display.

Examples — DSTORE A:4
DST B:2

Range — 0 to 8.

There is no DSTORE query.

DRECAL (recall display) command

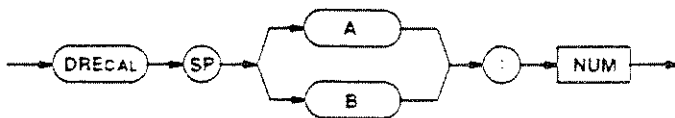

A — A waveform is recalled from the memory specified by NUM (0-8) and put in the A waveform display. If AVIEW is ON and BVIEW and BMINA are OFF, the readout associated with a recalled A waveform is displayed.

B — A waveform is recalled from the memory specified by NUM (0-8) and put in the B waveform display. If BVIEW or BMINA is ON, the readout associated with a recalled B waveform is displayed.

NOTE

The contents of B will be overwritten on the next sweep unless SINGLE SWEEP is ON.

Examples — DRECAL A:4
DRE B:2

Range — 0 to 8.

Interaction — DRECAL turns SAVEA ON. The B waveform display will be overwritten if the spectrum analyzer is not in the single-sweep mode. If you try to recall a waveform from an empty memory location, execution error message 62 will be issued.

There is no DRECAL query.

MXHLD (max hold) command

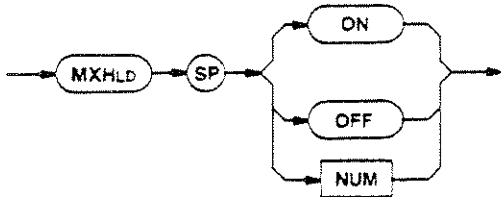

ON — Digital storage holds the maximum value obtained for each point in both the A and B waveforms; a point is updated only if the new value is greater than the current value. The A waveform is not affected if SAVEA is on.

OFF — The B waveform is continuously updated; the A waveform is updated only if SAVEA is OFF.

Power-up value — Off.

MXHLD (max hold) query



Response to MXHLD query

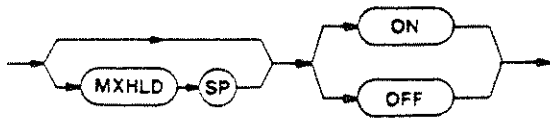

CRSOR (peak/average cursor) command

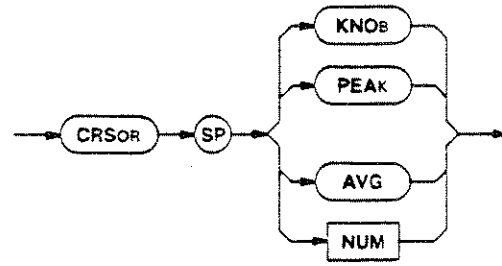

KNOB — The PEAK/AVERAGE control is under local control, so you can set the cursor level, which is shown by a line across the crt. Above the line, peak values are stored as each point is updated; below the line, averaged values are stored.

PEAK — The peak value digitized at each point is used to update digital storage, regardless of the cursor position last set by KNOB. This is the same as setting the cursor to its lowest (minimum) position.

AVG — Average values are used to update the waveforms, regardless of the cursor position last set by KNOB. PEAK AVG is the same as if the cursor is set to its highest (maximum) position.

- NUM — 0 = KNOB
- 1 = PEAK
- 2 = AVG

Interaction — Averaging can reduce the value in digital storage for signals with very narrow response or pulsed signals.

Power-up value — Knob.

CRSOR (peak/average cursor) query



Response to CRSOR query

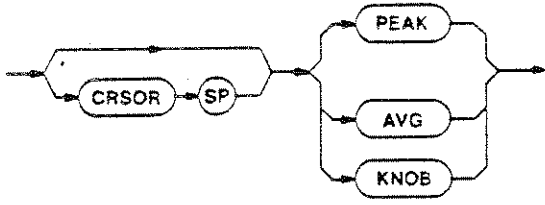

DISPLAY CONTROL

These commands control the spectrum analyzer crt display functions to display the readout (REDOUT), light the graticule (GRAT), and eliminate the baseline trace (CLIP).

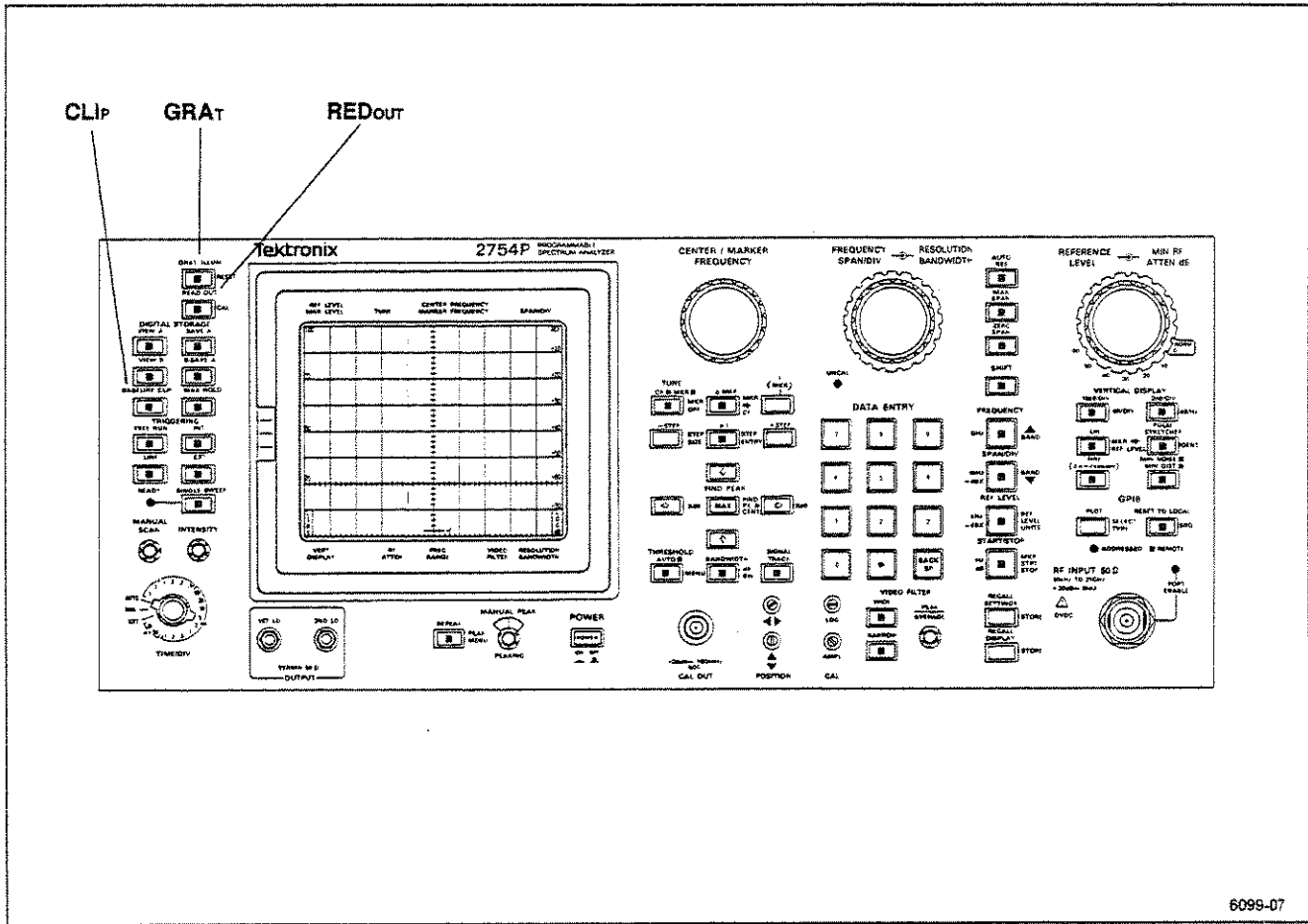
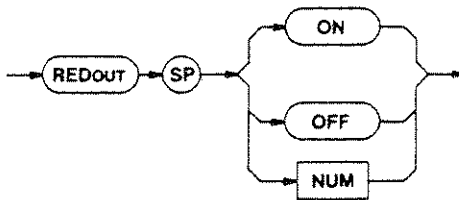

Figure 4-6. Front-panel Display Control commands.

REDOUT (readout) command



ON — The instrument settings are displayed.

OFF — The instrument settings are not displayed; the readout is blanked.

Power-up value — On.

REDOUT (readout) query



Response to REDOUT query

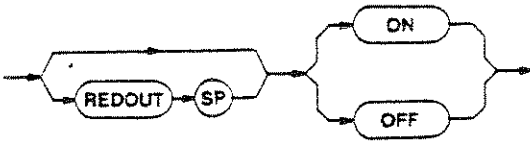

CLIP (blank baseline) command

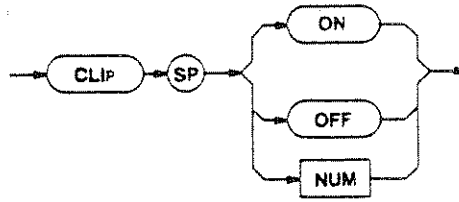

GRAT (graticule) command

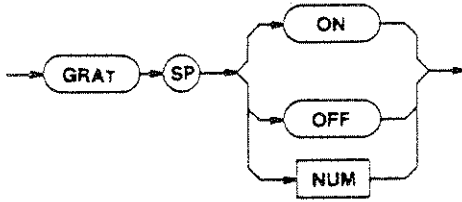

ON — The screen trace is turned off at the bottom of the crt.

OFF — The full trace is displayed on the crt.

Power-up value — Off.

CLIP (blank baseline) query



ON — The crt graticule is lighted.

OFF — The crt graticule is dark; not lighted.

Power-up value — Off.

Response to CLIP query

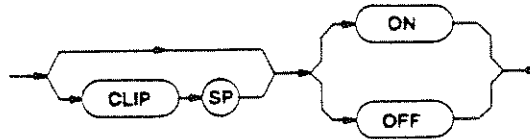

GRAT (graticule) query



Response to GRAT query

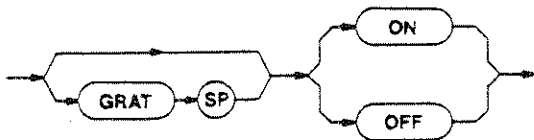

GENERAL PURPOSE

The general purpose commands and queries control the query response header (HDR) request front-panel help messages or GPIB command headers (HELP?), store settings in memory (STORE), recall settings from memory (RECALL), plot crt information (PLOT) on a choice of plotters (PTYPE), and change B-A reference for the plotter (POFSET).

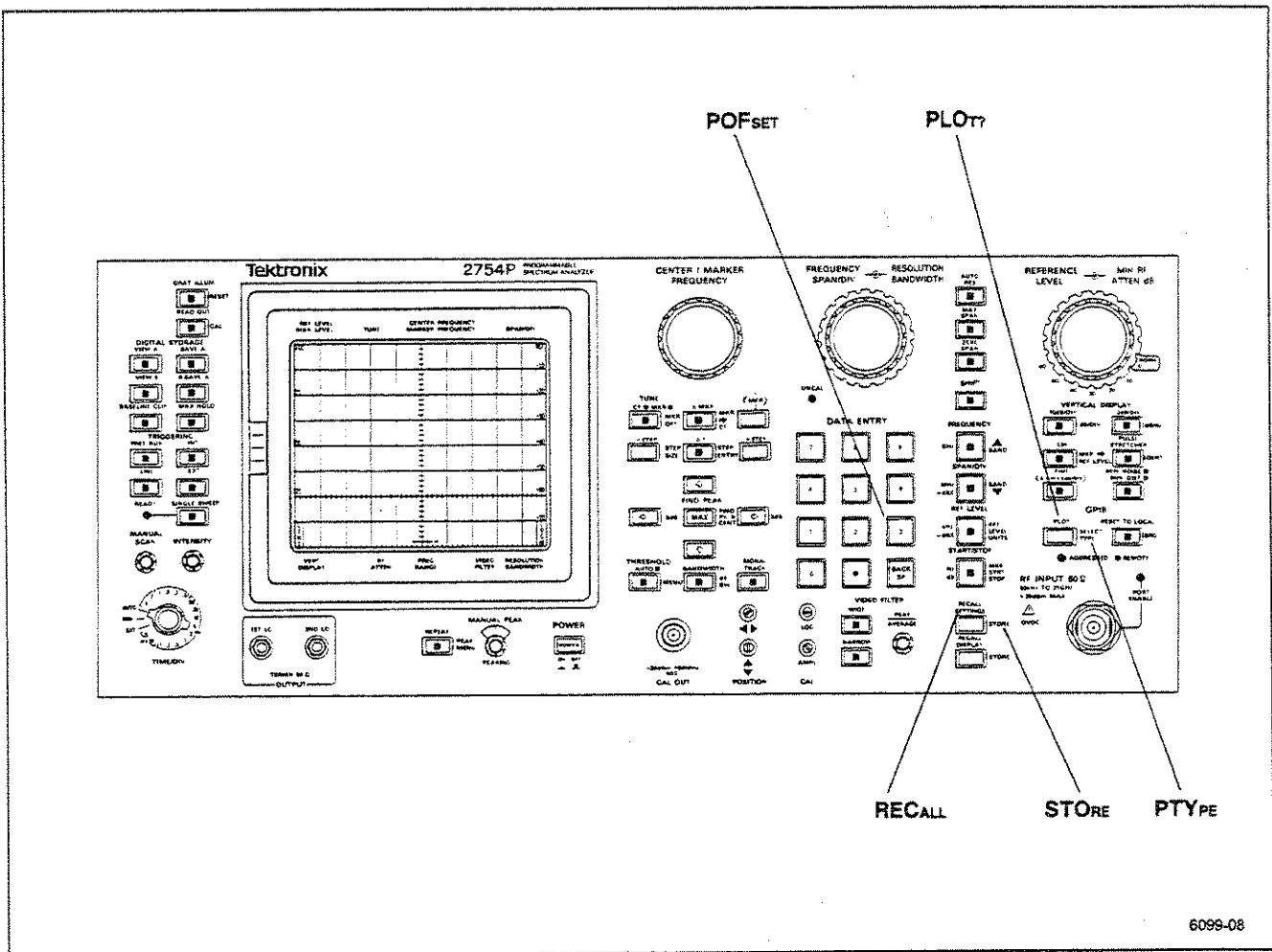
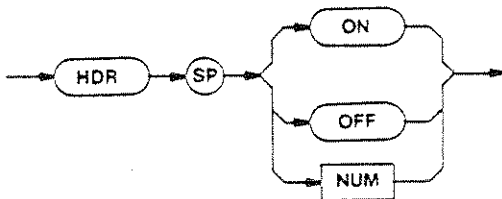

Figure 4-7. Front-panel General Purpose commands.

HDR (header) command



- ON — Turns on the header for the query response.
- OFF — Turns off the header for the query response.
- Power-up value — On.

Interaction — The HDR command has no effect on the SET? response, since the headers are necessary to interpret the response.

HDR (header) query



Response to HDR query

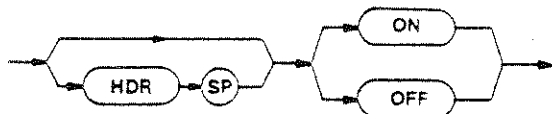

STORE (store settings) command



NUM — The spectrum analyzer control settings are stored into the selected memory location (range is 0–9).

Range — 0 to 9.

Power-up value — The spectrum analyzer STOREs its current settings in memory 0 automatically when the power is turned off, overwriting any previously-stored settings.

There is no STORE query.

RECALL (recall settings) command

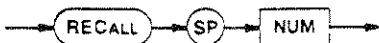

NUM — The spectrum analyzer control settings are recalled from the selected memory location (range is 0–9).

Range — 0 to 9.

Power-up value — The spectrum analyzer STOREs its current settings in memory 0 automatically when the power is turned off, overwriting any previously-stored settings.

Interaction — If you try to recall settings from an empty memory location, execution error message is issued.

There is no RECALL query.

PLOT query

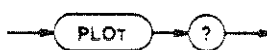

The PLOT query sends information to plot the display on a TEKTRONIX 4662 Opt 01, 4662 Opt 31 or 4663 (emulating a 4662) Interactive Digital Plotter, a Hewlett-Packard HP7470A, HP7475A, HP7580B, HP7585B, or HP7486B plotter, or a Gould 6310 or 6320 plotter.

- If REDOUT is ON the waveform, corresponding settings, and marker(s) will be plotted.
- If GRAT is ON, the scale down the right-hand side of the screen will be plotted, as well as the graticule and bezel information.
- Markers and digital storage must be on for the marker(s) to be plotted.
- The position of the marker(s) will be plotted out as an X.
- VIEWA must be ON to plot the A waveform, VIEWB must be ON to plot the B waveform, and BMINA must be ON to plot the difference between the A and B waveform.
- The readout settings currently displayed on the spectrum analyzer are the only readout settings plotted.
- The plot can be in more than one color when using the Tektronix 4662 Opt 31 (or the 4663 emulating the 4662), the HP7470A, HP7475A, HP7580B, HP7585B, or HP7586B, or the Gould 6310 or 6320. The graticule, marker(s), and bezel information will plot in one color, and the waveform in another color.
- If BWMODE is ON, the MKR LEVEL and MKR FREQUENCY will not be plotted. The bandwidth number the markers are at and the bandwidth will be plotted.

The response to PLOT? depends on the plotter in use.

NOTE

Since the GPIB languages of the Tektronix 4662 Opt 01, 4662 Opt 31 and 4663 Interactive Digital Plotters, the Hewlett-Packard, or the Gould plotters do not conform to the Tektronix Interface Standard for GPIB Codes, Formats, Conventions, and Features, this response does not follow the standard.

There is no PLOT command.

PTYPE (plotter type) command

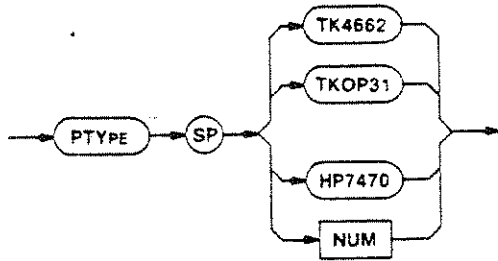

TK4662 — Selects the Tektronix 4662 Opt 01 (or the 4663 in a one-pen configuration) as the plotter driven by the data generated by PLOT?.

TKOP31 — Selects the Tektronix 4662 Opt 31 (or the 4663 in a two-pen configuration) as the plotter driven by the data generated by PLOT?.

HP7470 — Selects the Hewlett-Packard HP7470A as the plotter driven by the data generated by PLOT? (the rear-panel LF/EOI switch must be in the LF position).

MCOLOR — Selects the Hewlett-Packard HP7475A, 7580B, 7585B, or 7586B, or the Gould 6310 or 6320 as the plotter driven by the data generated by PLOT? (the rear-panel LF/EOI switch must be in the LF position).

- NUM—0 = TK4662
- 1 = TKOP31
- 2 = HP7470
- 3 = MCOLOR

PTYPE (plotter type) query



Response to PTYPE query

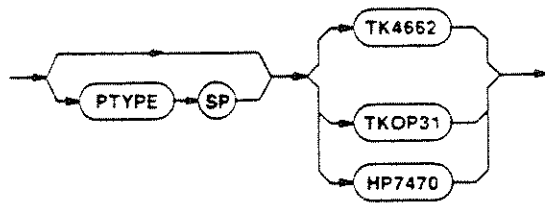

POFSET (set K) command

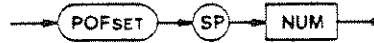

NUM — Sets K in the $(B-A)+K$ formula for plotting B-A waveforms using PLOT?. The bottom of the screen is 25 and the top of the screen is 225. K is set to the nearest limit if out of range (no error reported).

Range — 0 to 255.

MARKER SYSTEM

The digital storage functions (described in Section 4 of this manual) must be on for the marker(s) to be viewable. The Primary marker (single-marker mode) displays marker frequency and amplitude. A Secondary marker is added to the Primary marker in the delta-marker mode, and the difference in frequency and amplitude between the two markers is displayed. In the delta-marker mode, the Primary marker is the brighter of the two. The Secondary marker frequency can be changed only from the GPIB (no front-panel, operator control is available).

The GPIB marker commands in this section are divided into four categories: system control, marker positioning, marker finding, and miscellaneous.

WAVEFORM FINDING

The spectrum analyzer has two sets of waveform-finding commands; five commands are described in this section and two are described in Section 7 of this manual. The MRGTNXT and MLFTNXT marker positioning commands move the Primary marker, and RGTNXT and LFTNXT waveform processing commands move the invisible display data point. The Primary marker is specified and reported in frequency and amplitude, and the display data point is specified and reported in screen units. The two locations (marker and data point) and the two sets of commands are independent unless the Primary marker and the display data point are coupled with the MCPOIN command. The DPMK command moves the display data point to the Primary marker location without coupling the two, and MKDP moves the Primary marker to the horizontal location of the display data point, also without coupling the locations.

SYSTEM CONTROL

The system control commands turn on the marker mode (MARKER); set the Primary or Secondary marker on a trace (MTRACE); normalize the Primary marker amplitude readout to the resolution bandwidth (NSELVL); and keep the Primary marker signal at center screen (SGTRAK).

MARKER (marker mode) command

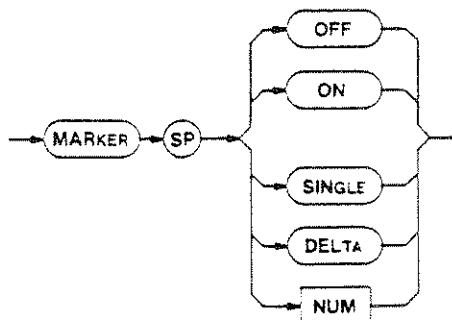

OFF — The marker is turned off.

ON or SINGLE — The single-marker is turned on.

DELTA — The delta-marker is turned on.

NUM — 0 = OFF
1 = ON or SINGLE
2 = DELTA

Power-up value — OFF

Interaction — MARKER SINGLE or ON or MARKER DELTA sets TMODE to MARKER. MARKER OFF sets TMODE to FREQ. MARKER SINGLE, or MARKER DELTA are selected by most other marker commands.

MARKER (marker mode) query



Response to MARKER query

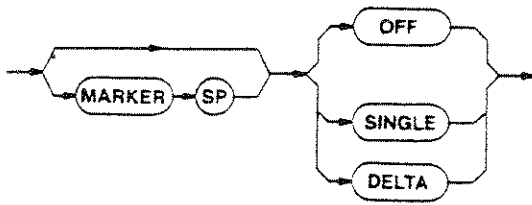

MTRACE (marker trace position) command

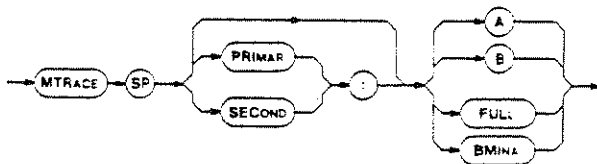

MTRACE allows either the Primary or Secondary marker to be placed on a trace location other than default. If the marker is moved off the active trace, it will go back to the active trace if the instrument is in MAX SPAN when it is returned to local control.

MTRACE or MTRACE PRIMAR — The Primary marker is set.

MTRACE SECOND — The Secondary marker is set.

Use A, B, FULL, or BMINA to place the selected marker on the designated trace.

Examples — MTRACE B

MTR PRI:A

MTRACE SECOND:BMINA

Power-up value — If the marker system is not turned on with the MTRACE command, the Primary marker location will be assigned according to the settings of the digital storage commands as shown in Table 5-1.

Table 5-1

PRIMARY MARKER TRACE ORGANIZATION

VIEWA	VIEWB	SAVEA	BMINA	Primary Marker Location
OFF	OFF	OFF	OFF	FULL ^a
OFF	OFF	ON	OFF	B ^a
OFF	OFF	ON	ON	B-A
OFF	ON	OFF	OFF	FULL
OFF	ON	ON	OFF	B
OFF	ON	ON	ON	B
ON	OFF	OFF	OFF	FULL
ON	OFF	ON	OFF	A
ON	OFF	ON	ON	B-A
ON	ON	OFF	OFF	FULL
ON	ON	ON	OFF	B
ON	ON	ON	ON	B

^aThe marker is assigned as shown; but, the marker is re-assigned when one of the digital storage traces is turned on.

If SAVEA is OFF or the Primary marker is on the BMINA trace, the Secondary marker (when in the delta-marker mode) is placed on the same trace as the Primary marker. Otherwise, the Secondary marker is placed on the A trace. This applies only to Table 5-1, not to any assignments with MTRACE.

Interaction — MTRACE SECOND sets MARKER to DELTA. If MARKER is OFF, MTRACE or MTRACE PRIMAR sets MARKER to SINGLE. Arguments A, B, and BMINA set SAVEA ON; argument FULL sets SAVEA OFF. SAVEA OFF moves any marker(s) on A or B to FULL; SAVEA ON moves any marker(s) on FULL to A or B, according to Table 5-1. Except when the marker system is first turned on, markers do not appear on A unless explicitly placed there. If BWMODE is ON, one MTRACE command will move both markers to the same trace.

MTRACE (marker trace position) query

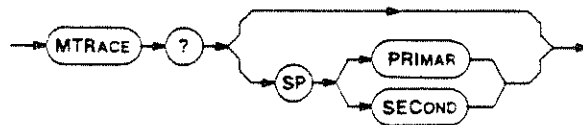

MTRACE? or MTRACE? PRIMAR — The trace containing the Primary marker is returned.

MTRACE? SECOND — The trace containing the Secondary marker is returned.

Examples — MTRACE?

MTR? SEC

Response to MTRACE query

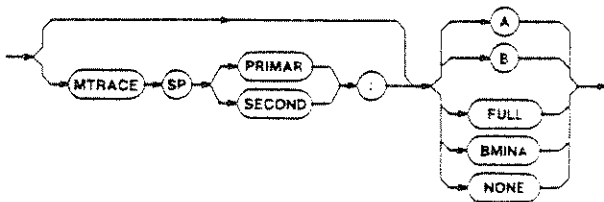

FULL is returned when SAVEA is OFF; A, B, or BMINA (B-Saved A) is returned when SAVEA is ON. NONE is returned when MARKER is OFF or when MTRACE? SECOND is requested while MARKER is set to SINGLE.

Interaction — If HDR is OFF, PRIMAR or SECOND and the following delimiter : are eliminated along with the MTRACE header.

NSELVL (noise level normalization) command

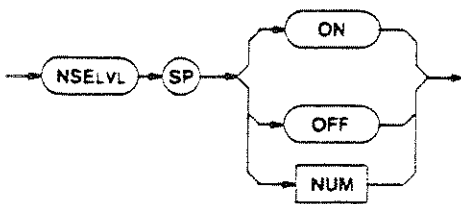

The Primary marker amplitude readout normalizes to the resolution bandwidth, and changes the units of the marker amplitude readout from units to units/HZ.

This command assumes the Primary marker is on noise, not on a signal. If the marker is on a signal, the marker amplitude readout is incorrect.

- ON — The normalization is turned on.
- OFF — The normalization is turned off.
- Power-up value — OFF.

Interaction — The marker amplitude readout is in reference level units/Hz. If MARKER is OFF, NSELVL sets MARKER to SINGLE.

NSELVL (noise level normalization) query



Response to NSELVL query

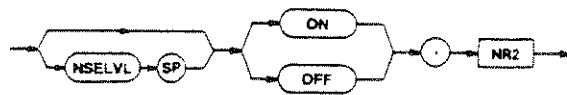

The noise level at the position of the Primary marker is returned, regardless of whether NSELVL is ON or OFF. The number is not returned with the NSELVL portion of the SET? response.

NOTE

If the Primary marker is out of the range of digital storage, one of the following will be returned

- -200.0 if under-range
- +200.0 if over-range
- +999.9 if markers are off

SGTRAK (signal track) command

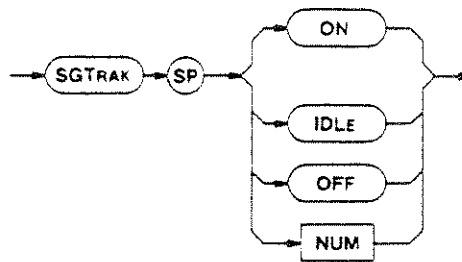

SGTRAK attempts to keep the signal at center screen as long as the signal does not drift off screen between sweeps. Marker execution error message 120 is issued if the marker is on an inactive trace. If there is no signal at the marker location or the signal disappears, SGTRAK goes to IDLE. The signal track function takes effect at the end of the sweep after the SGTRAK command is given. SGTRAK is on during IDLE, but it is not tracking because there is no signal at the marker location and marker execution warning message 130 is issued.

NOTE

The definition of the amplitude criteria for a signal is set by the THRHL D command.

ON or IDLE — The signal track is turned on.

OFF — The signal track is turned off.

Power-up value — OFF.

Interaction — If MARKER is OFF, SGTRAK sets MARKER to SINGLE. Neither IDENT nor BWMODE are available while SGTRAK is ON; execution error message 101 will be issued if either are used. The PEAK AUTO function is not available while SGTRAK is ON.

SGTRAK (signal track) query



Response to SGTRAK query

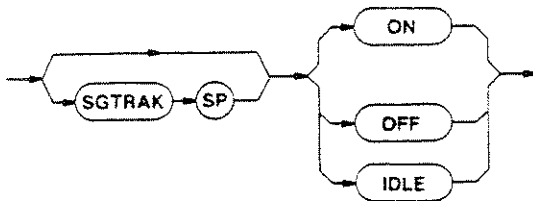

MARKER POSITIONING

The marker positioning commands and queries move the display pointer to the Primary marker position (DPMK); return the amplitude of the Primary or Secondary marker or their difference (MAMPL?); tune the Primary marker frequency to center screen (MCEN); track the Primary marker with the display pointer (MCPOIN); exchange the Primary and Secondary marker positions (MEXCHG); set the Primary marker frequency (MFREQ); move the Primary marker to the display pointer horizontal location (MKDP); return the frequency and amplitude of the Primary or Secondary marker or their difference (MLOCAT?); move the marker to the reference level (MTOPI); and tune the Primary marker (MTUNE).

DPMK (display pointer to marker) command

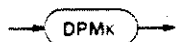

The DPMK command moves the display pointer to the Primary marker position.

Interaction — DPMK cancels the WFID portion of any previous WFMPRE command or the CRVID portion of any previous CURVE command, and selects the FULL waveform for data transfers and waveform processing. If

MARKER is OFF, DPMK sets MARKER to SINGLE

There is no DPMK query.

MAMPL (marker amplitude) query

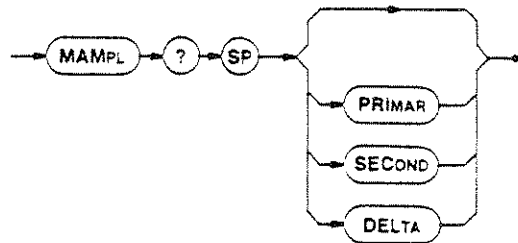

The returned marker amplitude has a resolution of 0.1 dB.

MAMPL? or MAMPL? PRIMAR — The amplitude of the Primary marker is returned.

MAMPL? SECOND — The amplitude of the Secondary marker is returned.

MAMPL? DELTA — The amplitude of the Primary marker with respect to the Secondary marker is returned.

NOTE

If the marker whose amplitude is being requested (or, in the case of MAMPL? DELTA, the amplitude of either marker) is out of the range of digital storage, one of the following will be returned.

- -200.0 if under-range
- +200.0 if over-range
- +999.9 if markers are off

Examples — MAMPL?

MAM? SEC

Interaction — The amplitude is returned in the current reference level units if in a log display mode or in volts if in a linear display mode. If the frequency of the Secondary marker is off-screen, MLOCAT? SECOND and MLOCAT? DELTA use the last known Secondary marker amplitude.

Response to MAMPL query

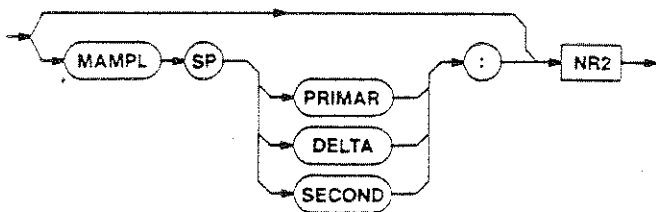

MAMPL is not included in the response to SET?

Interaction — If HDR is OFF, PRIMAR, SECOND, or DELTA and the delimiter : are eliminated along with the MAMPL header.

There is no MAMPL command.

MCEN (marker to center) command

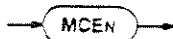

The Primary marker frequency is tuned to the center of the screen, and marker execution error message 121 is issued if the marker is not on an active trace.

Interaction — If MARKER is OFF, MCEN sets MARKER to SINGLE. In this case, since the Primary marker appears at the center of the screen, the center frequency does not change.

There is no MCEN query.

MCPOIN (marker coupled to the display pointer) command

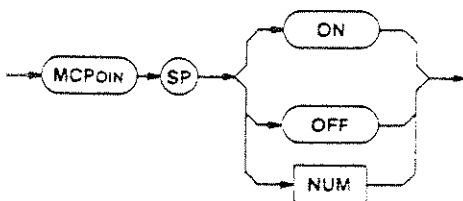

ON — The display pointer tracks the Primary marker.

OFF — The display pointer does not track the Primary marker.

Power-up value — OFF.

Interaction — The WFID portion of any previous WFMPRE command or the CRVID portion of any previous CURVE command is cancelled, and the FULL waveform for data transfers and waveform processing is

selected. A WFID or CRVID other than FULL sets MCPOIN to OFF. If MARKER is OFF, MCPOIN sets MARKER to SINGLE.

MCPOIN (marker coupled to the display pointer) query



Response to MCPOIN query

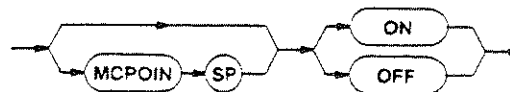

MEXCHG (marker exchange) command

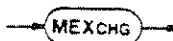

The Primary marker moves to the former location of the Secondary marker, and the Secondary marker moves to the former location of the Primary marker.

Interaction — MEXCHG sets MARKER to DELTA.

There is no MEXCHG query.

MFREQ (marker frequency) command

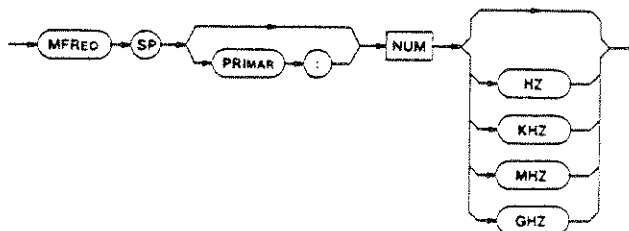

The MFREQ command sets the frequency of the Primary marker to the value given by NUM.

Examples — MFREQ 100000
MFREQ PRIMAR:200 KHZ
MFR PRI:200MHZ

Range—0 Hz to 21 GHz

Power-up value — Markers are off when power is first turned on to the instrument. When markers are turned on, MFREQ is set to the center frequency of the marker trace, unless the marker is on a recalled trace that had a stored marker frequency.

Interaction — If MARKER is OFF, MFREQ sets MARKER to SINGLE. MFREQ causes marker execution error message 120 to be issued if the Primary marker is on an inactive trace and the frequency is not on the screen. MFREQ moves the Primary marker to center screen and changes center frequency if the Primary marker is on an active trace and the frequency is not on the screen. In Option 01 versions, MFREQ does an automatic degauss to improve amplitude accuracy when the center frequency is changed more than 1 GHz in preselected bands.

MFREQ (marker frequency) query

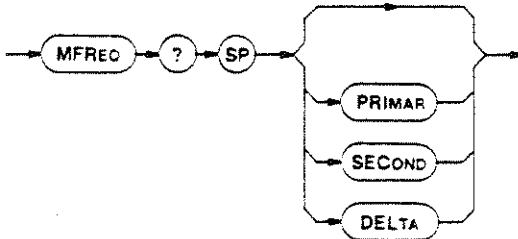

MFREQ? or MFREQ? PRIMAR — The frequency is returned for the Primary marker.

MFREQ? SECOND — The frequency is returned for the Secondary marker.

MFREQ? DELTA — The frequency is returned for the Primary marker with respect to the Secondary marker.

Interaction — Any MFREQ? query returns 9.999999E+99 if the requested marker or delta is not on.

Response to MFREQ query

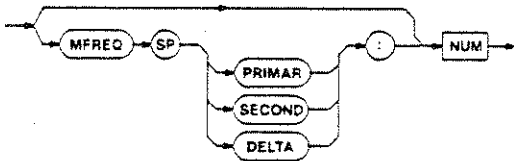

Interaction — If HDR is OFF, PRIMAR, SECOND, or DELTA and the following delimiter : are eliminated along with the MFREQ header.

MKDP (marker to display pointer) command

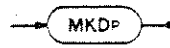

The Primary marker is moved to the same horizontal location as the display pointer.

Interaction — If MARKER is OFF, MKDP sets MARKER to SINGLE.

There is no MKDP query.

MLOCAT (marker location) query

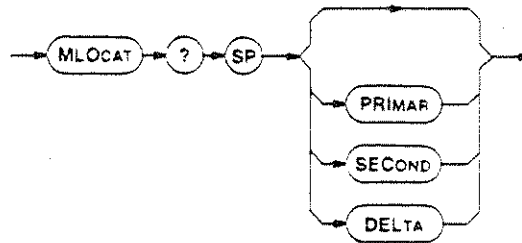

MLOCAT? or MLOCAT? PRIMAR — The amplitude and frequency are returned for the Primary marker.

MLOCAT? SECOND — The amplitude and frequency are returned for the Secondary marker.

MLOCAT? DELTA — The the amplitude and frequency are returned for the Primary marker with respect to the Secondary marker.

Interaction — In LOG, the amplitude is returned in reference level units. In LIN, the amplitude is returned in volts. If the frequency of the Secondary marker is off-screen, MLOCAT? SECOND and MLOCAT? DELTA use the last known Secondary marker amplitude.

NOTE

If the amplitude of the marker being requested is out of the range of digital storage, one of the following will be returned

- -200 if under-range
- +200 if over-range
- +999.9 if markers are off.

If the requested marker is off, 9.999999E+99 will be returned.

Response to MLOCAT query

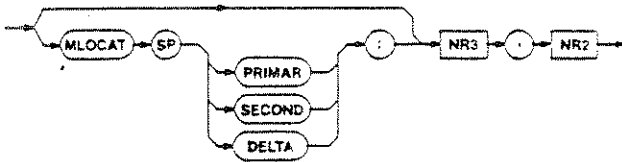

The marker frequency is returned first, followed by the marker amplitude. The resolution of marker amplitude is 0.1 dB. If the frequency of the Secondary marker is off-screen, MLOCAT? SECOND and MLOCAT? DELTA use the last known Secondary marker amplitude.

Interaction — If HDR is OFF, PRIMAR, SECOND, or DELTA and the following delimiter : are eliminated along with the MLOCAT header.

There is no MLOCAT command.

MTOP (marker to reference level) command

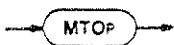

The MTOP command changes REFLVL to move the marker to the reference level (or as close as possible, given the specified vertical display and reference level accuracies).

Interaction — Marker execution error message 121 is issued if the Primary marker is on an inactive trace. If MARKER is OFF, MTOP sets MARKER to SINGLE.

There is no MTOP query.

MTUNE (tune marker) command

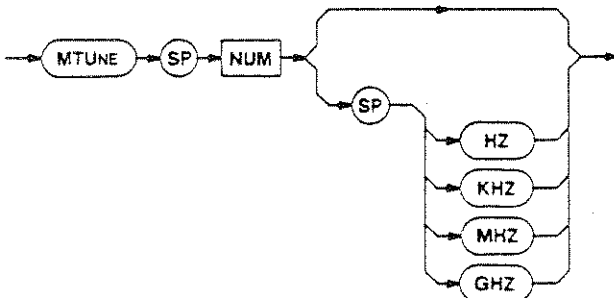

The Primary marker frequency is changed by the value of the number argument, and causes marker execution error message 120 to be issued if the marker is not on an active trace and the resulting marker frequency would not be on the screen.

MTUNE moves the Primary marker to center screen and changes center frequency if the Primary marker is on an active trace and the frequency is not on the screen. In Option 01 versions when using the preselector in internal mixer bands 2 through 5, MTUNE does an automatic degauss to improve amplitude accuracy when the center frequency is changed more than 1 GHz.

Examples — MTUNE 100
MTU 200 MHZ

Interaction — If MARKER is OFF, MTUNE sets MARKER to SINGLE.

There is no MTUNE query.

MARKER FINDING

The marker finding commands move the Primary marker to the next higher or lower amplitude signal (HRAMPL or LRAMPL); set the bandwidth number (BWNUM); places delta markers at a given amplitude (BWMODE); move the Primary marker to the largest on-screen signal peak (MFBIG); move the Primary marker to the next signal peak to the left or the right (MLFTNX or MRGTNX); set the Primary marker to the largest or smallest vertical value in digital storage (MMAX or MMIN); set the Primary marker to the largest vertical value in digital storage that is above threshold (PKFIND); set the threshold for the Primary marker signal find commands MLFTNX, MRGTNX, MFBIG, HRAMPL, LRAMPL, SGTRAK, BWMODE, and PKFIND (THRHLTD); move the Primary marker to the left, and down or up, or to the right, and down or up, from the present position (MVLFDB or MVRTDB); set the signal type (STYPE); and assert SRQ when the signal identification routine cannot find the requested signal (SGERR).

HRAMPL (next higher amplitude) command



The HRAMPL command moves the Primary marker to the next higher amplitude signal on the display. If the marker is on the highest signal on the display or if no signal is found, the marker does not move.

NOTE

The definition of the criteria for a signal is set by the THRHLTD and STYPE command.

Interaction — If SGERR is ON, marker execution warning message 130 is issued if a signal is not found. If MARKER is OFF, HRAMPL sets MARKER to SINGLE.

HRAMPL (next higher amplitude) query



Response to HRAMPL query

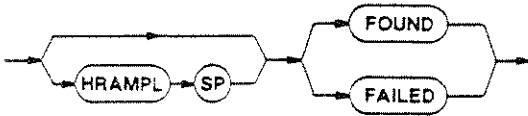

FOUND is returned if the last HRAMPL command found a signal. FAILED is returned if the last HRAMPL command did not find a signal. If the HRAMPL query is given before any HRAMPL command, FAILED is returned.

LRAMPL (next lower amplitude) command



The LRAMPL command moves the Primary marker to the next lower amplitude signal on the display. If the marker is on the lowest signal on the display or a signal cannot be found, the marker does not move.

NOTE

The definition of the criteria for a signal is set by the THRHL and STYPE command.

Interaction — If SGERR is ON, marker execution warning message 130 is issued if a signal is not found. If MARKER is OFF, LRAMPL sets MARKER to SINGLE.

LRAMPL (next lower amplitude) query



Response to LRAMPL query

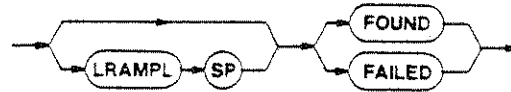

FOUND is returned if the last LRAMPL command found a signal. FAILED is returned if the last LRAMPL command did not find a signal. If the LRAMPL query is given before any LRAMPL command, FAILED is returned.

BWNUM (marker bandwidth number) command



BWNUM sets the level used in the bandwidth mode (BWMODE) below the signal peak at which the bandwidth is found. This number is stored in memory.

BWNUM (marker bandwidth number) query



Response to BWNUM query

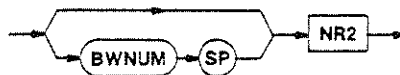

BWMODE (marker bandwidth mode) command

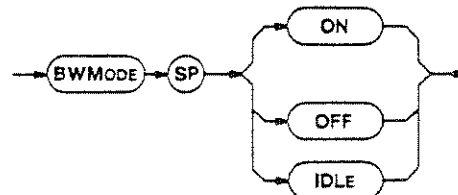

The BWMODE command moves the delta markers the value set in BWNUM down from the peak of the signal that the Primary marker is on. BWMODE moves in

1/10 dB steps, and places the markers at the end of every sweep on an active trace. The Primary marker is placed on the right (higher frequency) side of the signal and the Secondary marker is placed on the left (lower frequency) side of the signal. If the Primary marker is not on a signal or if a point NUM dB (set by the BWNUM command) down cannot be found on each side of the signal, the Secondary marker moves to the location of the Primary marker, and BWMODE goes to IDLE. When BWMODE goes to IDLE, marker execution warning message 130 is issued.

NOTE

The definition of the amplitude criteria for a signal is set by the THRHL D command.

Power-up value — Off.

Interaction — BWMODE sets MARKER to DELTA. The markers are reset after the marker position or BWNUM is changed. The PEAK AUTO function is not available while BWMODE is ON.

BWMODE (marker bandwidth mode) query



Response to BWMODE query

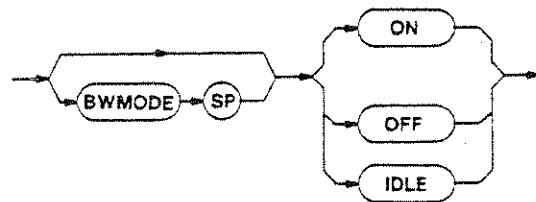

MFBIG (marker peak find) command



The MFBIG command moves the Primary marker to the peak of the largest on-screen signal. If no signal peak is found, the marker does not move.

NOTE

The definition of the criteria for a signal is set by the THRHL D and STYPE command.

Interaction — If MARKER is OFF, MFBIG sets MARKER to SINGLE. If SGERR is ON, marker execution warning message 130 is issued if a signal is not found.

MFBIG (marker peak find) query



Response to MFBIG query

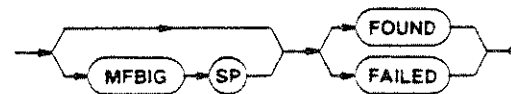

FOUND is returned if the last MFBIG command found a signal. FAILED is returned if the last MFBIG command did not find a signal. If the MFBIG query is given before any MFBIG command, FAILED is returned.

MLFTNX (marker left next) command

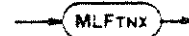

The MLFTNX command moves the Primary marker to the peak of the next signal to the left of the present marker position. If no signal peak is found, the marker does not move.

NOTE

The definition of the criteria for a signal is set by the THRHL D and STYPE command.

Interaction — If MARKER is OFF, MLFTNX sets MARKER to SINGLE. If SGERR is ON, marker execution warning message 130 is issued if a signal is not found.

MLFTNX (marker left next) query:



Response to MLFTNX query

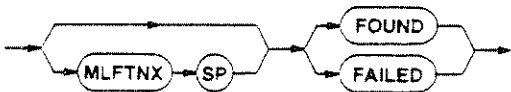

FOUND is returned if the last MLFTNX command found a signal. FAILED is returned if the last MLFTNX command did not find a signal. If the MLFTNX query is given before any MLFTNX command, FAILED is returned.

PKFIND (marker to maximum above threshold) command



The Primary marker is moved to the largest left-most vertical value in digital storage if that value is above the threshold. If no value is found above the threshold, the marker does not move. PKFIND locates the left-most peak (or the center peak of a cluster), but it is not a signal processing command with the built-in intelligence. Peak B would be selected from the cluster in Figure 5-1A; peak A would be selected in Figure 5-1B because the low point (B) would stop a search from continuing to the cluster (C).

NOTE

The definition of the amplitude criteria for a signal is set by the THRHLD command.

Interaction — If MARKER is OFF, PKFIND sets MARKER to SINGLE. If SGERR is ON, marker execution warning message 130 is issued if a value is not found.

PKFIND (marker to maximum above threshold) query



Response to PKFIND query

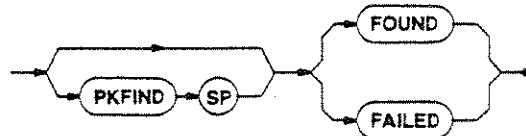

FOUND is returned if the last PKFIND command found a signal. FAILED is returned if the last PKFIND command did not find a signal. If the PKFIND query is given before any PKFIND command, FAILED is returned.

Interaction — PKFIND does not use STYPE.

MMA1 (move marker to maximum) command

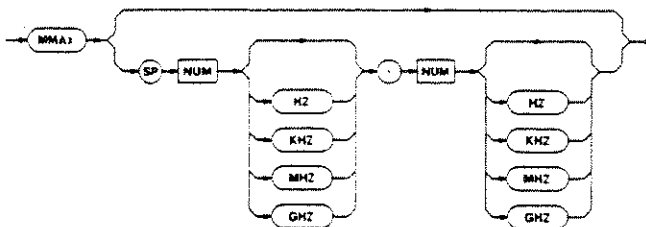

The MMA1 command sets the Primary marker to the largest vertical value in digital storage. If the largest value is located at more than one point, the first (left-most) point is used.

NUM, NUM — The optional arguments are two frequency values. If these are present, the search is limited to the intersection of the given frequency range and the range displayed on the screen. If the given range is totally outside the range displayed on the screen, execution error message 28 is issued.

Examples — MMA1

- MMA1 15.0MHZ,19.0MHZ
- MMA1 8.0GHZ,10.0GHZ
- MMA1 4.0GHZ,6.3GHZ

Interaction — If MARKER is OFF, MMA1 sets MARKER to SINGLE.

There is no MMA1 query.

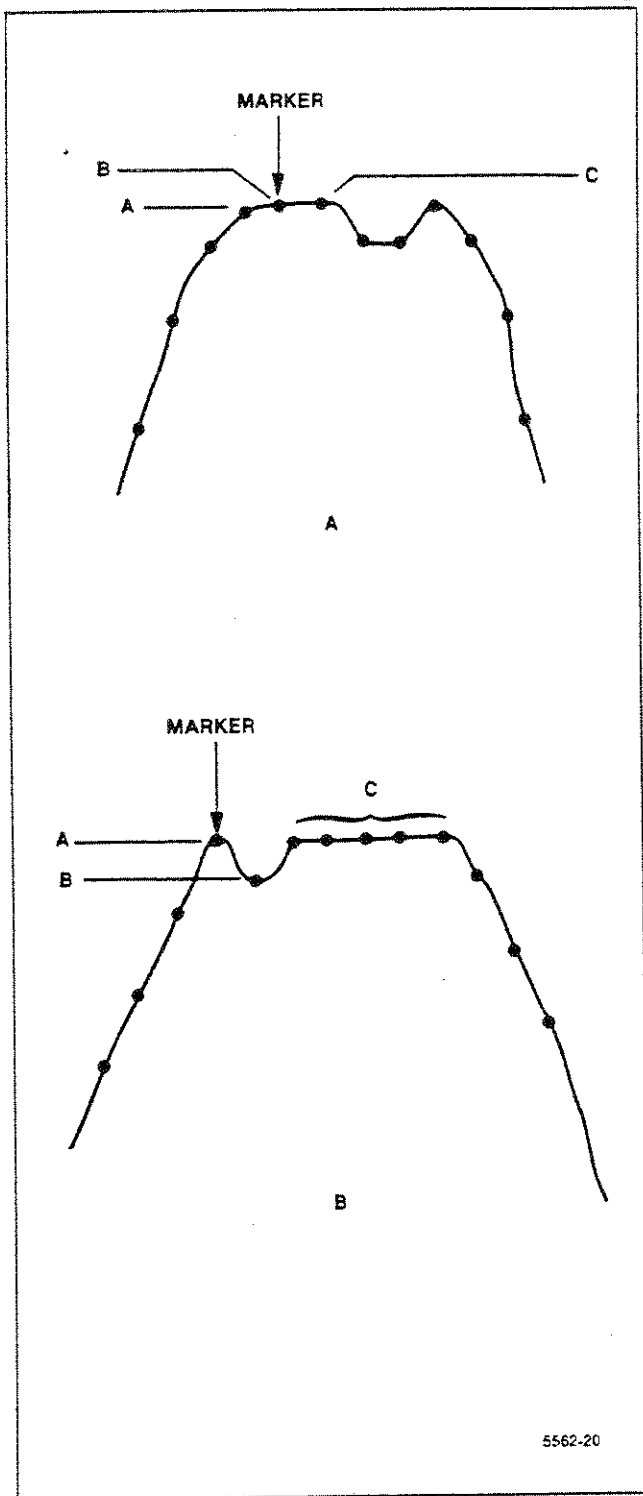
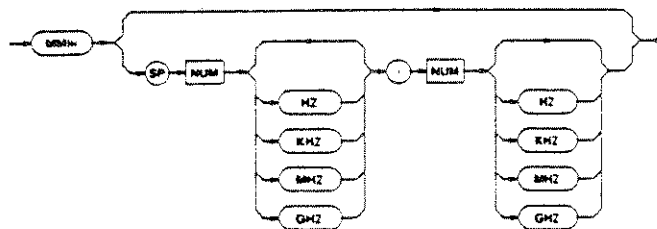

Figure 5-1. Using the PKFIND command.

MMIN (move marker to minimum) command



The MMIN command sets the Primary marker to the smallest vertical value in digital storage. If the smallest value is located at more than one point, the first (left-most) point is used.

NUM, NUM — The optional arguments are two frequency values. If these are present, the search is limited to the intersection of the given frequency range and the range displayed on the screen. If the given range is totally outside the range displayed on the screen, execution error message 28 is issued.

Examples — MMIN

- MMIN 15.0MHZ,19.0MHZ
- MMI 8.0GHZ,10.0GHZ
- MMIN 4.0GHZ,6.3GHZ

Interaction — If **MARKER** is OFF, **MMAX** sets **MARKER** to **SINGLE**.

There is no **MMAX** query.

MRGTNX (marker right next) command



The **MRGTNX** command moves the Primary marker to the peak of the next signal to the right of the present marker position. If no signal peak is found, the marker does not move.

NOTE

The definition of the criteria for a signal is set by the **THRHL** and **STY** command.

Interaction — If **MARKER** is OFF, **MRGTNX** sets **MARKER** to **SINGLE**. If **SGERR** is ON, marker execution warning message 130 is issued if a signal is not found.

MRGTNX (marker right next) query



Response to MRGTNX query

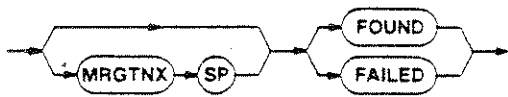

FOUND is returned if the last MRGTNX command found a signal. FAILED is returned if the last MRGTNX command did not find a signal. If the MRGTNX query is given before any MRGTNX command, FAILED is returned.

THRHL D (marker threshold) command

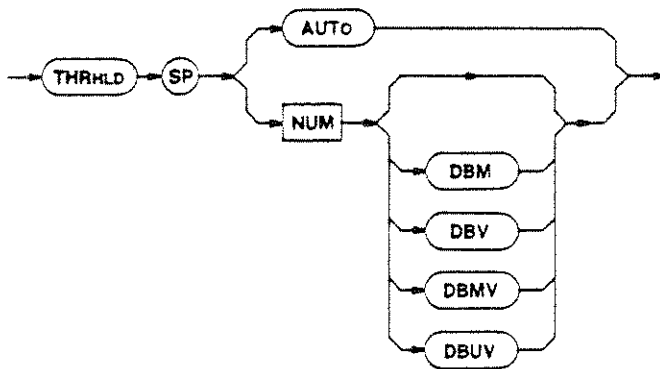

NOTE

To ensure the correct response, all of the letters in each of the unit mnemonics for the THRHL D command must be entered; not just the first three letters as required for other mnemonics.

The THRHL D command sets the threshold for the marker signal find commands MLFTNX, MRGTNX, MFBIG, HRAMPL, and LRAMPL. THRHL D moves in 1 dB steps.

AUTO — The threshold is set to approximately the sensitivity specification plus RF attenuation plus the video filter offset. The video filter offset is 10 dB if there is no filter, 4 dB if WIDE is ON, and 2 dB if NARROW is ON.

NUM — The threshold is set to level input. If no units are specified, the spectrum analyzer assumes the current reference level units.

Examples — THRHL D AUTO
THRHL D -40DBMV

THRHL D (marker threshold) query



Response to THRHL D query

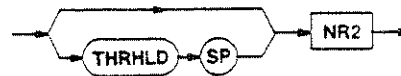

MVLFDB (move marker left x dB) command

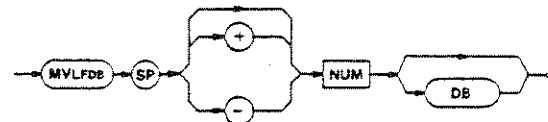

The MVLFDB command moves the Primary marker to the left and NUM DB down (negative NUM) or up (positive NUM or NUM without a sign) from the current position. If the requested amplitude cannot be found, the marker does not move.

Interaction — If MARKER is OFF, MVLFDB sets MARKER to SINGLE. If SGERR is ON, marker execution warning message 130 is issued if the requested amplitude is not found.

MVLFDB (move marker left x dB) query



Response to MVLFDB query

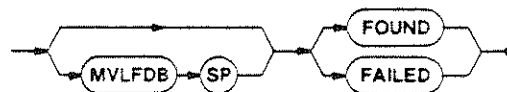

FOUND is returned if the last MVLFDB command moved the marker to the requested position. FAILED is returned if the last MVLFDB command could not move the marker to the requested position. If the MVLFDB query is given before any MVLFDB command, FAILED is returned.

MVRTDB (move marker right x dB) command

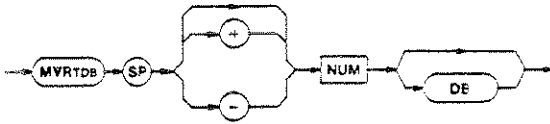

The MVRTDB command moves the Primary marker to the right and NUM DB down (negative NUM) or up (positive NUM or NUM without a sign) from the current position. If the requested amplitude cannot be found, the marker does not move.

Interaction — MARKER is OFF, MVRTDB sets MARKER to SINGLE. If SGERR is ON, marker execution warning message 130 is issued if the requested amplitude is not found.

MVRTDB (move marker right x dB) query



Response to MVRTDB query

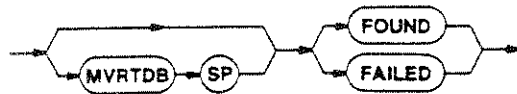

FOUND is returned if the last MVRTDB command moved the marker to the requested position. FAILED is returned if the last MVRTDB command could not move the marker to the requested position. If the MVRTDB query is given before any MVRTDB command, FAILED is returned.

STYPE (signal type) command

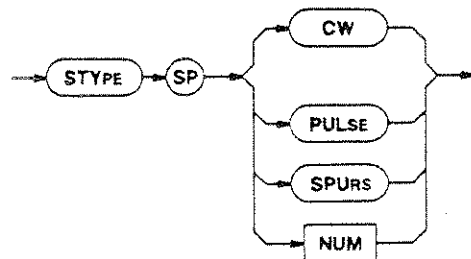

- CW — Continuous wave signals are identified.
- PULSE — The signal peak is located.
- SPURS — All signals above the threshold are identified.
- NUM — 0 = OR CW
1 = PULSE
2 = SPURS

Figure 5-2 is a signal enlarged to show how the spectrum analyzer locates the signal peak with one of the signal processing commands. The signal processing commands are MLFTNX, MRGTNX, MFBIG, HRAMPL, and LRAMPL. The spectrum analyzer looks at both the individual left-most and right-most peaks of a signal. From this reading, the spectrum analyzer calculates the exact center of the signal. If this location is one of the maximum digital storage points, the marker is positioned here. If, as in Figure 5-2, the calculated center of the signal is not equal to the maximum digital storage point, the marker is positioned on the closest point to the center. At the end of this Marker Functions portion are five illustrations showing the use of this signal finding command.

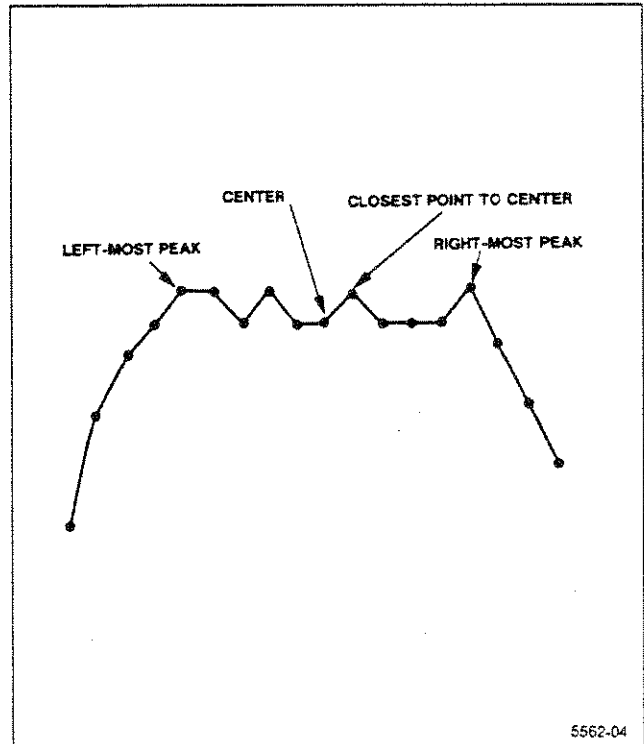

Figure 5-2. Locating the signal peak.

To the finding routine, a signal consists of a peak above threshold and two points (one on each side of the peak) that are 3 dB below the peak. The location of the signal is the highest amplitude point on the signal. Figures 5-3 through 5-5 illustrate the use of STYPE. All of the figures use the signal finding command of MRGTNX. Any of the other signal finding commands (MLFTNX,

MFBIG, HRAMPL, and LRAMPL) work similarly, according to their specific function. The minimum bandwidth criteria is defined as the two 3 dB down points that must be <5 kHz (1/2 a resolution bandwidth) apart.

Figures 5-3A, 5-3B, and 5-4A — If CW was selected, the spectrum analyzer would not identify any signal because none of the signals displayed meets the minimum bandwidth criteria. If PULSE was selected, the signals labeled D, E, and F would be identified because the other signals in the display are less than 2 minor divisions apart. If the signals were greater than 2 minor divisions apart, PULSE would have identified all labeled signals (A, B, C, etc.). If SPURS was selected, all signals would be identified (A, B, C, etc.).

Figure 5-5 — The MRGTNX selection begins at the left screen margin. With this display, CW, PULSE, and SPURS will each identify all of the signals because they all meet the minimum bandwidth criteria (i.e., the selections would be A, B, C, D, and E).

Figure 5-4B — In Figure 5-4B the threshold is assumed to be -70 dBm. If CW was selected, signals B, E, F, and G would be identified. The other signals would not be identified because they do not meet the minimum bandwidth criteria. If Pulse was selected, signals A, B, D, E, F, and G would be identified. Signal C would be skipped, because it is within 2 minor divisions from signal B. The PULSE algorithm will think signal C is a part of signal B. If Spurs was selected, all signals would be identified.

Power-up status — CW.

Interaction — The STYPE command affects the marker finding commands MFBIG, MLFTNX, MRGTNX, HRAMPL, and LRAMPL.

STYPE (signal type) query



Response to STYPE query

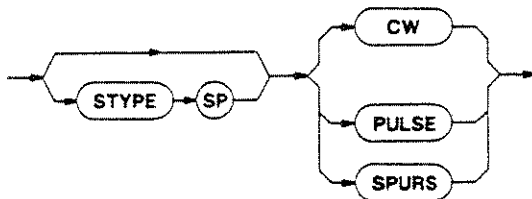

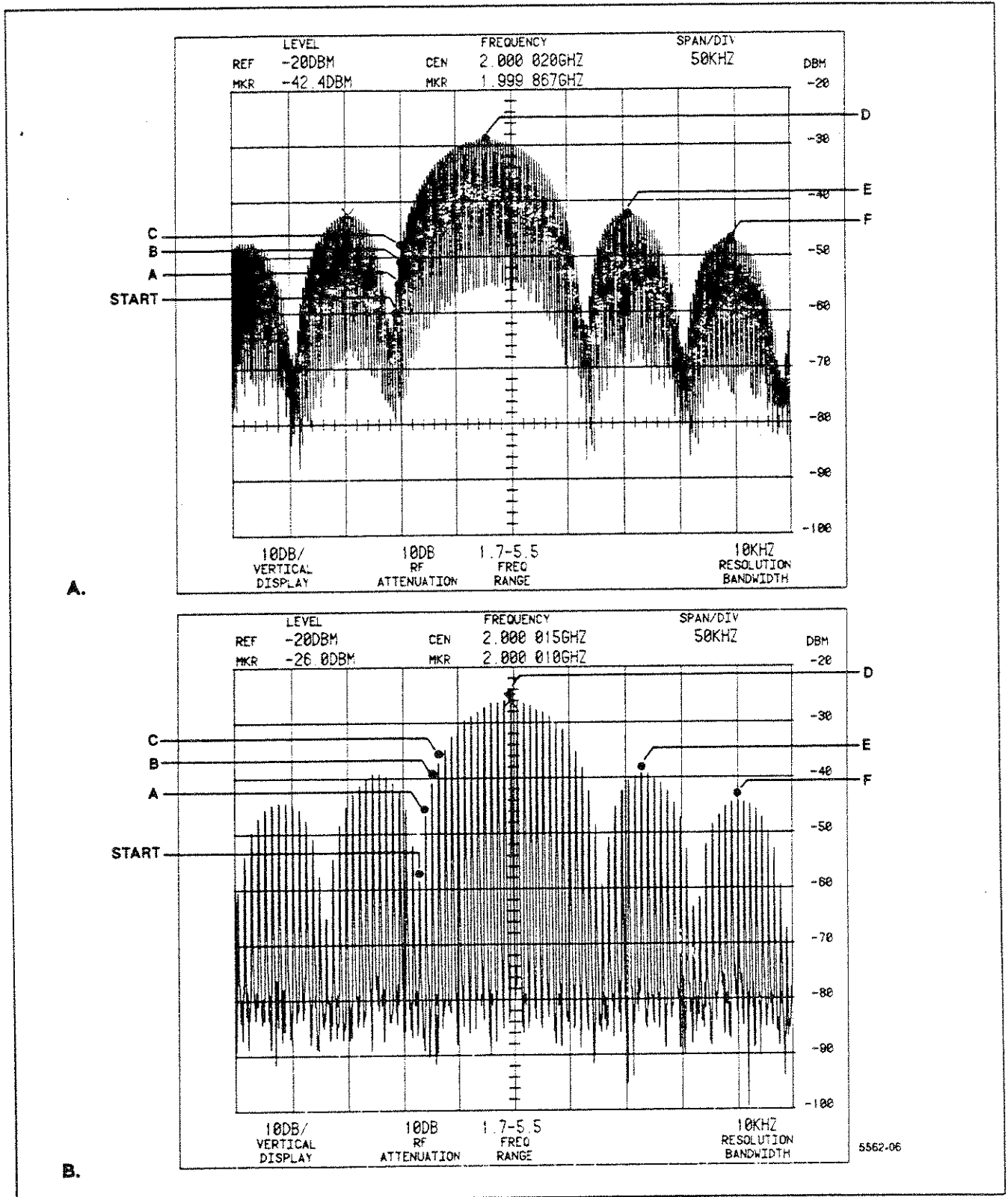

Figure 5-3. Signal finding examples.

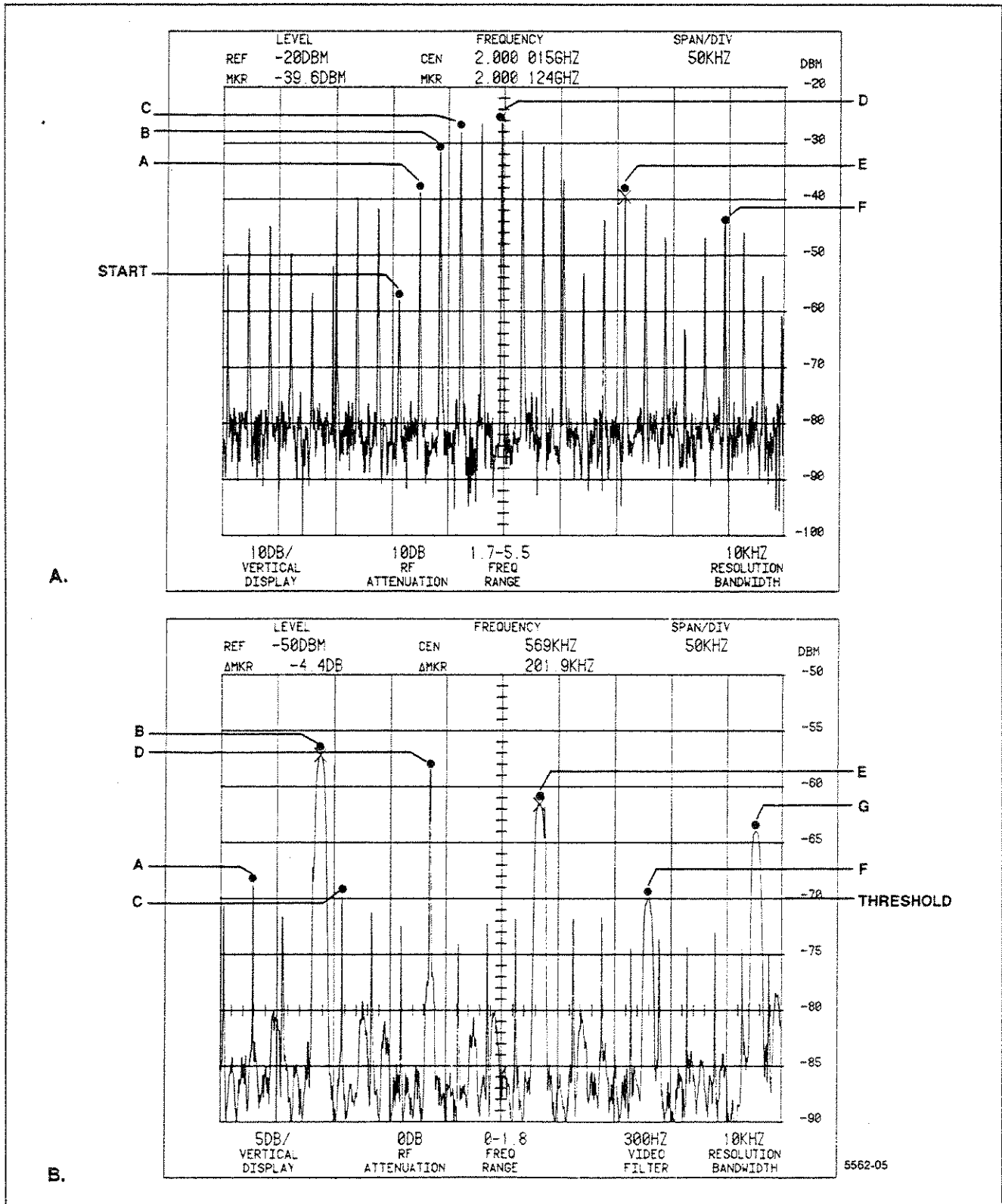

Figure 5-4. Signal finding examples.

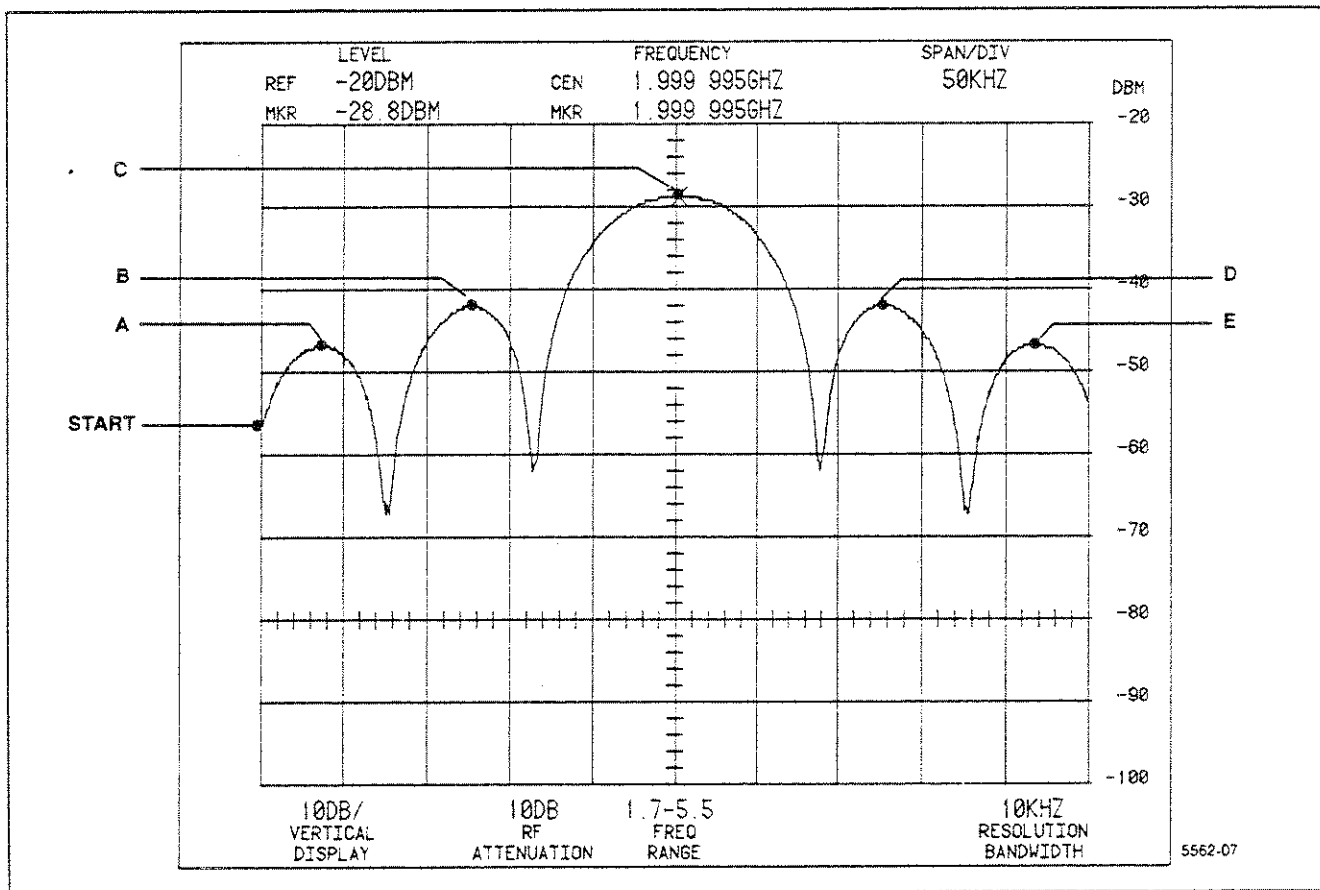

Figure 5-5. Signal finding example.

OFF — The spectrum analyzer does not assert SRQ when any of the above commands fail.

Power-up value — OFF.

Interaction — RQS must be on for marker execution warning message 130 to be issued.

SGERR (signal find error) command

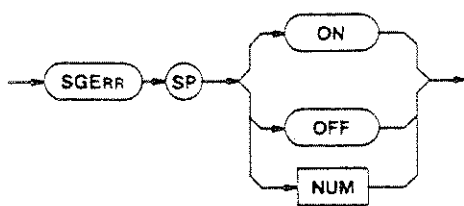

ON — The spectrum analyzer asserts SRQ, if RQS is ON, when either of the following conditions exist.

- The internal signal identification routine cannot find the signal requested by the MFBIG, MRGTNX, MLFTNX, HRAMPL, or LRAMPL commands.
- The internal signal identification routine cannot find the amplitude requested by the PKFIND, MVRTDB, or MVLFDDB commands.

SGERR (signal find error) query



Response to SGERR query

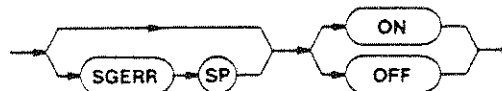

MISCELLANEOUS

ZOOM command

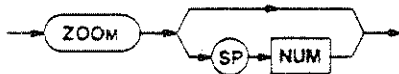

The ZOOM command moves the Primary marker frequency to the center frequency and sets the SPAN (frequency span/division) to the next smaller span/division, if possible, in the front-panel 1-2-5 sequence. If the optional number argument is given, the span/division is reduced NUM times. Numbers less than 1 are rounded to 1. Execution warning message 111 is issued if the spectrum analyzer defaults to the lowest span/division because the span could not be reduced the requested number of times.

Interaction — Marker execution error message 121 is issued if the Primary marker is not on an active trace. If MARKER is OFF, ZOOM sets MARKER to SINGLE. In this case — since the marker initially appears at the center screen — the effect is to decrement the span only.

There is no ZOOM query.

DISPLAY DATA AND CRT READOUT I/O

The spectrum analyzer follows the Tektronix Interface Standard for GPIB Codes, Formats, Conventions, and Features for waveform transfer. The commands and queries in this section transfer display and readout data to or from the spectrum analyzer and are divided into two categories; waveform transfers, and crt readout transfers.

WAVEFORM TRANSFERS

The waveform transfers begin with a waveform preamble (WFMPRE) that identifies and scales the data and data (CURVE) that represents the waveform. A query (WAVFRM?) displays the responses to the WFMPRE and CURVE queries. The display preamble (DPRE?) contains the numeric data necessary to reproduce the display. The display units necessary to make a hard copy of the display (DCOPY?) can be transmitted to another unit. A readout command (RDOUT) displays messages on the crt in either a 2-line or a 16-line mode (TEXT). Three crt readout queries return the upper row of characters (UPRDO), the middle row (MDRDO), or the lower row (LORDO).

WFMPRE (waveform preamble) command

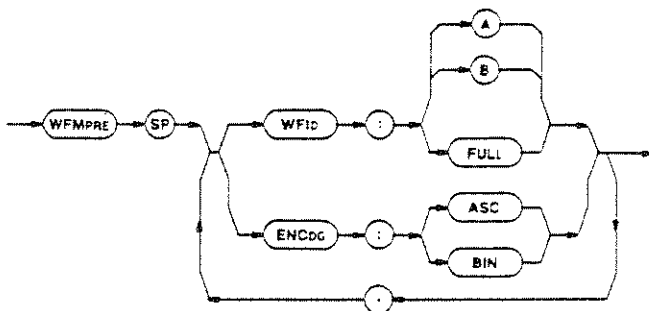

NOTE

The WFMPRE command has no effect on the Marker Finding commands in Section 5 of this manual.

The WFID path of the waveform preamble command allows the choice of either the A or B waveform or both (FULL). Following the ENCDG path, the waveform preamble command allows selection of either ASCII-coded

decimal or binary waveform data.

The contents of digital storage determine if a half-resolution or full-resolution waveform is obtained, or two different waveforms. This is because of the way digital storage is handled in the spectrum analyzer.

The B waveform is updated with each sweep; the A waveform is updated only if SAVEA is OFF. The values stored for each waveform are alternate points on the current display (i.e., B, A, B, A, B, A, ... beginning at the left edge of the screen and moving to the right).

With SAVEA OFF, each waveform is a half-resolution replica of data from the last sweep (A data points offset by 1 from corresponding B data points). Full-resolution (FULL) transfers merge the two waveforms for 1000 data points (100 points/div), and half-resolution transfers (A or B) separate the waveforms for 500 data points (50 points/div). If the waveforms are separated, signals resolved to a single point (with very narrow resolution bandwidths compared to span) appear in either A memory or B memory, but not both.

With SAVEA ON, only the B waveform is filled with data from the current sweep, so half-resolution transfers can involve two unrelated waveforms.

WFID — Either the A or B waveform or both A and B (FULL) waveforms are selected for data transfers and waveform processing.

ENCDG — Either ASCII-coded decimal numbers or binary numbers are selected for data transfer.

The two arguments may be selected independently or strung together in the same command.

Examples — WFMPRE WFID:FULL
WFMPRE ENCDG:ASC
WFM WFID:A,ENC:BIN

Power-up value — Full (1000 point), ASCII-coded digits.

Interaction — The WFID portion of any previous WFMPRE command or the CRVID portion of any previous CURVE command is cancelled, and the FULL waveform for data transfers and waveform processing is selected. A WFID or CRVID other than FULL sets WFMPRE to OFF.

WFMPRE (waveform preamble) query



Response to WFMPRE query

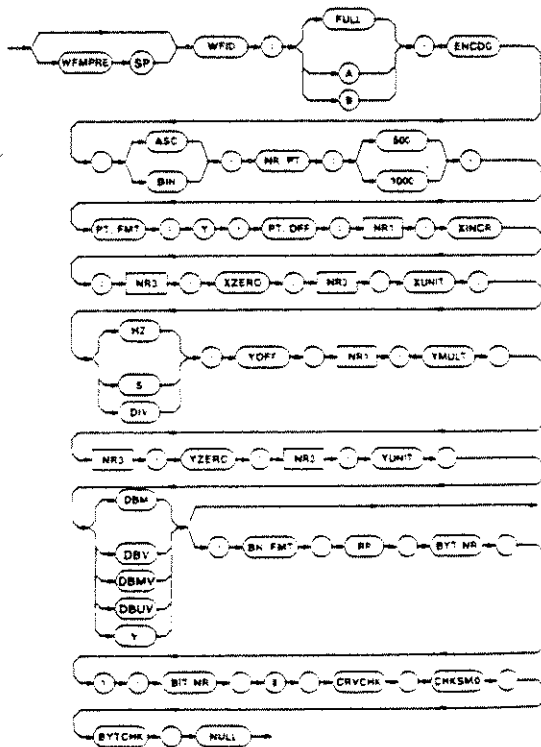

Items that follow the waveform identification and coding specify other data packet parameters that refer to number of points, scaling, and error checking.

NR.PT — Specifies either 500 or 1000 points in the curve to follow.

PT.FMT:Y — Indicates all curve data is Y (display vertical) values. The data is ordered; each point's X (display horizontal) value is determined by its point number and parameters in the waveform preamble.

PT.OFF — Relates the first point to the X origin by the point offset.

XINCR — Is the difference between adjacent data points.

XZERO — Points to the X origin.

XUNIT — Identifies the horizontal display units in hertz, seconds, or divisions.

YOFF — Relates Y data to the Y origin by the Y offset.

YMULT — Scales the Y values.

YZERO — Points to the Y origin.

YUNIT — Identifies the units that apply to the Y values dBm, dBV, dBmV, dBµV, or volts.

BN.FMT:RP — Means each binary number (single byte) stands for a binary positive integer.

BYT/NR:1 — Means that binary numbers or ASCII-coded digits are transferred as single bytes.

BIT/NR:8 — Indicates the precision (max number of significant bits) of the binary numbers.

CRVCHK:CHKSM0 — Specifies that the last byte of a binary transfer is a 2's complement, modulo-256 check sum for the preceding bytes (except for the first byte, which is a percent sign).

BYCHK:NULL — Indicates no byte check is appended to binary data transfers.

X-Axis Scaling

X-axis specifications XINCR, PT.OFF, and XZERO are used to interpret the position of the ordered points as absolute X values.

$$XN = XZERO + XINCR * (N-PT.OFF)$$

where:

XN is the value in XUNITS on the X axis

XZERO is the center frequency, except in the following cases;

$$XZERO = 0 \text{ for time-domain data (ZEROSP)}$$

XINCR is the absolute point-to-point distance on the X axis;

- XINCR = (span/div)/100 for FULL in frequency domain
- XINCR = (span/div)/50 for A or B in frequency domain
- XINCR = TIME/100 for FULL in time domain
- XINCR = TIME/50 for A or B in time domain

N is the point number (0, 1, 2, 3, ...)

PT.OFF is graticule center for frequency-domain transfers and left graticule edge for time-domain transfers

- PT.OFF = 250 for A or B in frequency domain
- PT.OFF = 500 for FULL in frequency domain
- PT.OFF = 0 in time-domain

For example, point 100 could have the following absolute values

- XN = 997 MHz for A or B with FREQ 1 GHz and SPAN 1 MHz
- XN = 996 MHz for FULL with FREQ 1 GHz and SPAN 1 MHz
- XN = 2 ms for FULL with SPAN 0 and TIME 2 ms

Y-Axis Scaling

Y-axis specifications YMULT, YZERO, and YOFF are used to interpret the data as the absolute value of the ordered data points

$$Y_N = YZERO + YMULT * (VALN - YOFF)$$

where:

Y_N is the value in YUNITS of point number N

YZERO is the reference level in log vertical display mode and 0 in linear vertical display mode

YMULT is the scale factor divided by 25

VALN is the unscaled integer data at point N

YOFF is 225 (top edge of graticule) in log vertical display mode and 25 (bottom edge of graticule) in linear vertical display mode

For example, data value 125 (graticule center) could have the following absolute values

- Y_N = -40 dBm at 10 dB/div with a reference level of 0 dBm
- Y_N = 0.112 V in linear mode with a reference level of 0 dBm

The WFMPRE portion of the SET? response includes only the WFID and ENCDG arguments.

CURVE (display curve) command

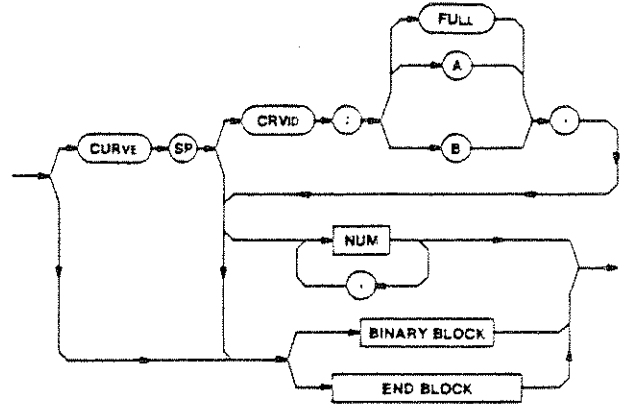

NOTE

The instrument should be in the Single Sweep mode and not be sweeping during the CURVE command or query. If it is sweeping during the CURVE query, it could give erroneous information.

CRVID — The destination (A, B, or FULL) is selected for the waveform being sent. If this argument is omitted, the last CRVID in a CURVE command or WFID in a WFMPRE command takes precedence. A or B indicates a 500-point transfer; FULL indicates 1000 points.

NUM — This is a sequence of ASCII-coded digits, delimited by commas between successive numbers.

BINARY BLOCK — Binary block is a sequence of binary numbers that is preceded by the ASCII code for percent (%) and a two-byte binary integer representing the number of binary numbers plus one (the extra byte is the checksum) and followed by the checksum. The checksum is the 2's-complement of the modulo-256 sum of all preceding bytes except the first (%). Thus, the modulo-256 sum of all bytes except the first (%) should equal zero to provide an error-check of the binary block transfer.

END BLOCK — End block is a sequence of binary numbers that is preceded by the ASCII code for at (@); EOI must be asserted concurrently with the last data byte. The end block can only be the last data type in the message.

Examples — CURVE CRVID:FULL,100,100,101,99,
 <996 more numbers>
 CURVE <500 or 1000 numbers>
 CUR <BINARY BLOCK>

Interaction — A waveform sent in a CURVE command is overwritten in the display I/O buffer if preceded by a CURVE query in the same message. This causes the queried display data to be put back into digital storage.

SGTRAK and BWMODE use the same buffer as where GPIB stores the waveform display, so execution warning message 53 could be sent (multiple use of display buffer). CRVID sets the data used in the FIBIG, LFTNXT, RGTNXT, POINT, FMAX, and FMIN commands. See Display Data Point Commands Interaction under waveform processing for more information.

CURVE (display curve) query



Response to CURVE query

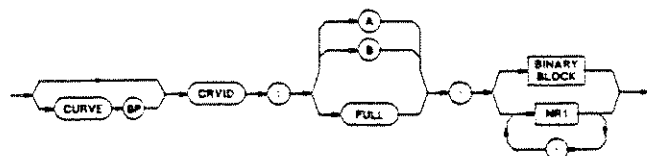

Waveform data is related to the display by Figure 6-1.

WAVFRM (waveform) query



The WAVFRM query response is the same as the response to WFMPRE?;CURVE?. The most recent WFID and CRVID arguments select whether A, B, or both memories are selected for data transfers and waveform processing in ASCII or binary numbers (refer to both the WFMPRE and CURVE queries).

There is no WAVFRM command.

DPRE (display preamble) query



DPRE? calls for the transmission of the display preamble. The display preamble contains numeric data items to be used with corresponding curves to reproduce a display.

Response to DPRE query

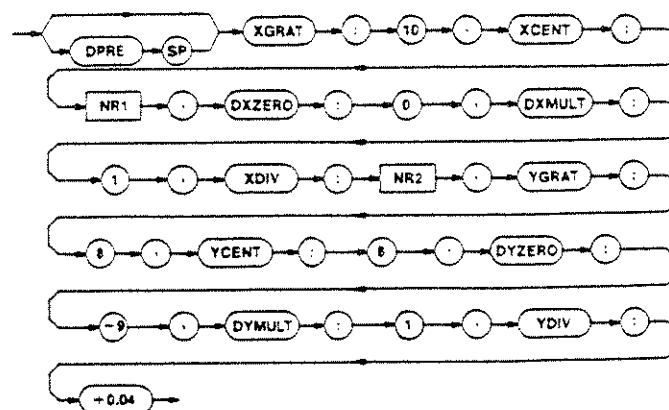

XGRAT:10 — Specifies the X (horizontal) graticule size.

XCENT — Is the X center of the display data in number of divisions relative to the left-hand side of the graticule.

DXZERO:0 — Displays the X offset in divisions relative to XCENT.

DXMULT:1 — Displays the X multiplier.

XDIV — Displays X divisions/unit.

YGRAT:8 — Specifies the Y (vertical) graticule size.

YCENT:8 — Is the Y center of the display in number of divisions relative to the bottom of the graticule.

DYZERO:-9 — Displays the Y offset in divisions relative to YCENT.

DYMULT:1 — Displays the Y multiplier.

YDIV:+0.04 — Displays Y divisions/unit.

X-Axis Scaling

X-axis specifications XGRAT, XCENT, DXZERO, DXMULT, and XDIV are used to interpret the position of the ordered points in absolute X values.

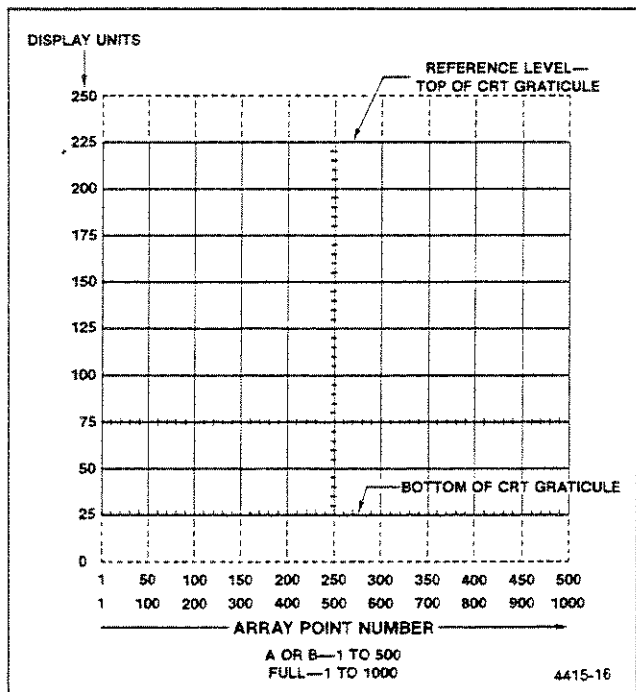

Figure 6-1. Waveform data related to the display.

$$DXN = DXMULT * (N - PT.OFF) * XDIV + XCENT + DXZERO$$

where:

DXN is the X value in graticule divisions

Y-Axis Scaling

Y-axis specifications YGRAT, YCENT, DYZERO, DYMULT, and YDIV are used to interpret the position of the ordered points in absolute Y values.

$$DYN = DYMULT * VALN * YDIV + YCENT + DYZERO$$

where:

DYN is the Y value in graticule divisions
VALN is the current data value

There is no DPRE command.

DCOPY (copy display) query



The DCOPY query response is the same as the response to ID?;WFMPRE?;DPRE?;CURVE?. It allows transmission of information from one device to another in "display" units, so that a hard copy can be made of the display.

There is no DCOPY command.

CRT READOUT TRANSFERS

Readout messages (RDOUT) can be displayed on the crt screen in either a 2-line or a 16-line mode (TEXT). Three crt readout queries return the upper row of normal readout characters (UPRDO), the middle row (MDRDO), or the lower row (LORDO).

RDOUT (readout message) command

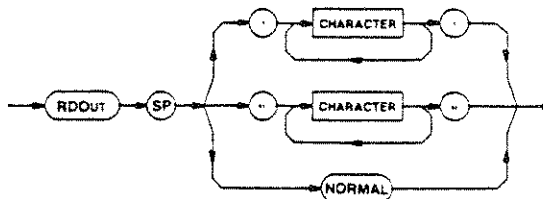

CHARACTER — In the TEXT SHORT mode, the spectrum display remains on the crt, the readout is cleared, and up to the first 40 characters, enclosed in either single or double quotes, are displayed across the bottom of the spectrum analyzer crt. When the RDOUT command sends a new line of characters, it is entered at the bottom of the crt and the previous bottom line of characters is moved to the top of the crt. Each succeeding line of characters is displayed at the bottom of the crt, and the previous bottom line moves to the top, discarding the previous top line. Thus, each new RDOUT command causes the spectrum analyzer readout to scroll. All characters are displayed as upper-case characters.

In the TEXT LONG mode, the screen is completely blanked and up to the first 40 remotely-entered characters are displayed in the 1st line at the top of the crt screen. Successive lines of characters are entered on the following lines until the 16th (bottom) line is reached. Then, as each successive line of characters is entered, the entire screen scrolls up one line, the first line is discarded, and the new RDOUT command characters become the 16th line.

NORMAL — Normal spectrum analyzer readout is restored.

Power-up value — Normal readout.

There is no RDOUT query.

TEXT command

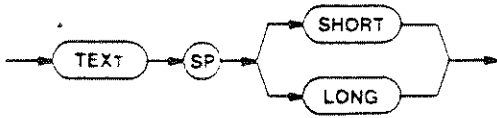

SHORT — The readout is switched to the 2-line mode with a spectrum display. RDOUT commands will send characters to these two lines.

LONG — The readout is switched to the 16-line mode without a spectrum display. RDOUT commands will fill the top line first, then fill successive lines until all lines have characters. When all 16 lines are full of characters, the entire screen scrolls up. Send TEXT LONG again to clear the page of all readout, and begin sending characters to the top line again.

Power-up value — SHORT

Interaction — If the crt readout is not in the NORMAL mode when TEXT is executed, the readout will be cleared (this could be used as a "page" command to clear the screen for new text). RDOUT NORMAL restores normal spectrum analyzer readout.

TEXT query



Response to TEXT query

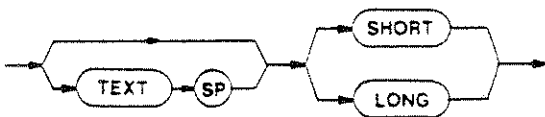

UPRDO (upper readout) query



Response to UPRDO query

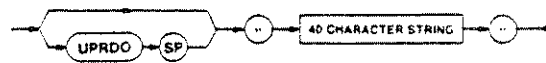

CHARACTER — Characters are from the upper row of regular crt readout. Blanks are transmitted as spaces. Regular readout that would be displayed if GPIB did not have control (whether visible on the screen or not) is the readout returned by the query, not a message sent to the instrument by RDOUT. With AVIEW and SAVEA both ON and BMINA and BVIEW both OFF, the returned readout will be the saved readout. Refer to the recall display command (DRECAL) in Section 4 of this manual.

There is no UPRDO command.

MDRDO (middle readout) query

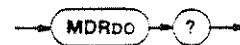

Response to MDRDO query

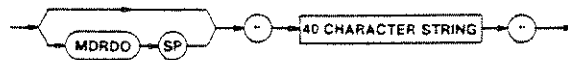

CHARACTER — Characters are from the middle row of regular crt readout. Blanks are transmitted as spaces. Regular readout that would be displayed if GPIB did not have control (whether visible on the screen or not) is the readout returned by the query, not a message sent to the instrument by RDOUT. With AVIEW and SAVEA both ON and BMINA and BVIEW both OFF, the returned readout will be the saved readout. Refer to the recall display (DRECAL) or the save A waveform (SAVEA) commands in Section 4 of this manual.

There is no MDRDO command.

LORDO (lower readout) query



Response to LORDO query

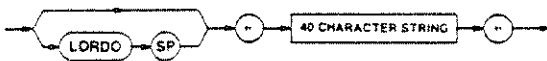

CHARACTER — Characters are from the lower row of regular crt readout. Blanks are transmitted as spaces. Regular readout that would be displayed if GPIB did not have control (whether visible on the screen or not) is the readout returned by the query, not a message sent to the instrument by RDOUT. With AVIEW and SAVEA both ON and BMINA and BVIEW both OFF, the returned readout will be the saved readout. Refer to the recall display command (DRECAL) in Section 4 of this manual.

There is no LORDO command.



WAVEFORM PROCESSING

The commands in this section allow local processing of spectrum data by the spectrum analyzer. Some of these commands operate on a display data point. This is an ordered pair (an X and a Y value) that corresponds to a point on the spectrum analyzer display. On command, the spectrum analyzer gets a display data point from the current digital storage waveform. The point is held in memory until another command updates the data point. A query requests that the spectrum analyzer report the point. Other commands change spectrum analyzer settings automatically to center it exactly on the point.

Commands that update the display data point direct the spectrum analyzer to a new point (POINT), find the largest or nearest signal (FIBIG, LFTNXT, RGTNXT), or search for the maximum or minimum value (FMAX, FMIN). A query (POINT?) returns the X and Y values of the display data point.

This section covers how the waveform processing commands and query work. Two programs at the end of Section 2 in this manual show some of these commands in use. Waveform processing techniques are offered in Section 9 of this manual.

WAVEFORM FINDING

The spectrum analyzer has two sets of waveform-finding commands; two commands are described here and five are described in Section 5 of this manual. The RGTNXT and LFTNXT waveform processing commands move the invisible display data point, and the MRGTNXT and MLFTNXT marker commands move the Primary marker. The display data point is specified and reported in screen units, and the Primary marker is specified and reported in frequency and amplitude. The two locations (data point and marker) and the two sets of commands are independent unless the display data point and the Primary marker are coupled with the MCPOIN command. The DPMK command moves the display data point to the Primary marker location without coupling the two, and MKDP moves the Primary marker to the horizontal location of the display data point, also without coupling the commands.

POINT (display data point) command

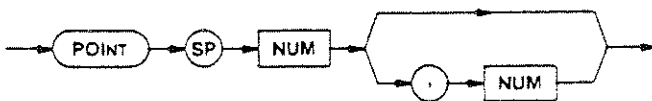

First NUM — This is the X value of a display data point. The horizontal scale is always the same as a full, 1000-point waveform, as explained under Display Data Point Commands Interaction later in this section.

Second NUM — This is the Y value of a display data point. The vertical scale is the same as illustrated for the CURVE query in Section 6 of this manual.

If the second number is not entered, digital storage is asked for the value of the waveform at X (the first number). This makes the display data point correspond to a point in digital storage. If the second number is supplied in the POINT command, the display data point may not correspond to any point in digital storage.

Examples — POINT 500,150 (center screen)
POI 1,25 (screen bottom left)
POI 1000,225 (screen top right)

Power-up value — 500,225.

Interaction — The SET? response sent back to the instrument sets both the X and Y values of the display data point, which may not correspond to any point in digital storage. See Display Data Point Commands Interaction.

POINT (display data point) query

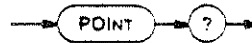

Response to POINT query



The first number is the X value of the display data point; the second number is the Y value of the display data point. Note that the query response may not match any point in digital storage if the Y value was set by a POINT command or if digital storage was updated after the display data point was acquired.

FIBIG (find big) command

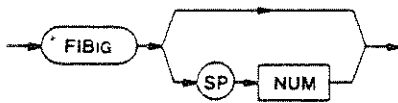

This command seeks to acquire the largest signal peak with a point of greater value than NUM. If a signal peak greater than NUM is not found, the display data point is set to 500,0.

A pattern recognition routine is used to recognize signals. If NUM is omitted from the command, a default value of 0 is used.

Interaction — See Display Data Point Commands Interaction.

There is no FIBIG query.

LFTNXT (left next) command

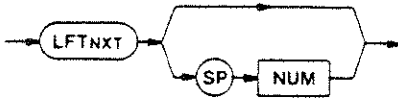

This command searches to the left of the current point to acquire the peak of a signal whose value is greater than NUM. If a signal peak greater than NUM is not found, the display data point is set to 0,0.

A pattern recognition routine is used to recognize signals. If NUM is omitted from the command, a default value of 0 is used.

Interaction — See Display Data Point Commands Interaction.

There is no LFTNXT query.

RGTNXT (right next) command

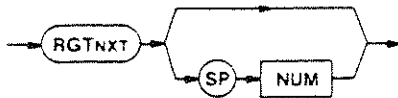

This command searches to the right of the current point to acquire the peak of a signal whose value is greater than NUM. If a signal peak greater than NUM is not found, the display data point is set to 1001,0.

A pattern recognition routine is used to recognize signals. If NUM is omitted from the command, a default value of 0 is used.

Interaction — See Display Data Point Commands Interaction.

There is no RGTNXT query.

FMAX (find maximum value) command

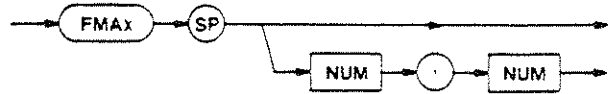

This routine sets the display data point to the point in digital storage with the largest Y value. If the largest Y value is located at more than one point, the first (left-most) point is acquired. The optional arguments are two display X values. The FMAX command will limit its search over this X range; otherwise, the full X range (1 to 1000) will be searched.

Interaction — See Display Data Point Commands Interaction.

There is no FMAX query.

FMIN (find minimum value) command

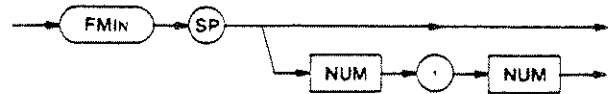

This routine sets the display data point to the point in digital storage with the smallest Y value. If the smallest Y value is located at more than one point, the first (left-most) point is acquired. The optional arguments are two display X values. The FMIN command will limit its search over this X range; otherwise, the full X range (1 to 1000) will be searched.

Interaction — See Display Data Point Commands Interaction.

There is no FMIN query.

Data Point Commands Interaction

1. The waveform processing commands in this section operate only on the waveform specified by the last WFMPRE or CURVE command; either A or B or full (both A and B). The waveform involved is first copied into a buffer. If the waveform is only half-resolution (either A or B), it is duplicated in the buffer to make a full 1000-point waveform before processing. Thus, whether the com-

mand operates on A or B or both, the range of X values for the display data point is always 1 to 1000.

2. The waveform processing commands in this section that update the display data point use the same buffer memory as display data I/O; therefore, commands for these two functions can interact if executed as part of the same message. This command interaction can cause invalid data output with either CURVE? or CURVE.

(a) When two particular conditions exist together, it can cause CURVE? data output commands to be invalid:

(1) if CURVE? is followed by a command to update the display data point, and

(2) if digital storage is updated during the execution of the message (either by repetitive sweeps or by the SIGSWP command).

When both of these conditions exist, the curve data output that follows completion of the entire message will not be the data that was loaded in the buffer at the time CURVE? was executed. Instead, the curve data that is output will be the data that was loaded by the later command to update the display data point, because this later data overwrites the data already loaded in the buffer at the time CURVE? was executed. The curve data is output as expected if CURVE? follows the command to update the display data point instead of preceding it, because no conflict occurs in the way the commands use the buffer.

(b) If CURVE follows a command to update the display data point, the display data output commands may be invalid. In this case, the curve data is loaded into the buffer as it is received from the GPIB, but it is overwritten when the display data point is updated. This overwriting causes the data already loaded into the buffer from digital storage to be written back into digital storage when the CURVE command is then executed with the updated data. The overwriting also causes the curve data sent to the instrument to be lost.

One exception to the potential interaction just described is when a Y as well as an X value is sent with the POINT command. In that case, since both values are established by POINT, digital storage data is not read into the buffer and the interaction does not occur.

3. VRTDSP LIN interacts with FIBIG, RGTNXT, and LFTNXT because they transform linear data into logarithmic data before execution. This interaction is not apparent unless the transformed data is output over the GPIB or loaded into digital storage because of either of the conditions noted in part 2.

For further information, refer to Multiple Use of Display Buffer for Waveform Processing and I/O in Section 9 of this manual.

CENSIG (center signal) command

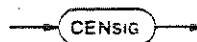

This command TUNES the frequency to center the signal represented by the display data point (or as close as possible, given the specified span accuracies).

This command does not get a new display data point or digital storage waveform. Therefore, if a new waveform is acquired after CENSIG is run, the display data point may no longer match the signal of interest.

TOPSIG (move to top of graticule) command



This command changes REFLVL to move the signal represented by the display data point to the reference level (or as close as possible, given the specified vertical display and reference level accuracies).

This command does not acquire a new display data point or digital storage waveform. Therefore, if a new waveform is acquired after TOPSIG is run, the display data point may no longer match the signal of interest.



SYSTEM COMMANDS AND QUERIES

Spectrum analyzer device-dependent message units are provided to set and return parameters of use to the controller in a GPIB system. These commands and queries are described in this section in three groups related to instrument parameters, message execution, and status and error reporting.

INSTRUMENT PARAMETERS

The commands and queries in this group return instrument settings (SET?), return the instrument identification parameters (ID?), initialize settings (INIT), and control return of the query response header (HDR).

SET (instrument settings) query



Response to SET query

The instrument returns a string of commands that can be "learned" for later transfer to the spectrum analyzer when the same setup is desired. The response includes only those functions necessary for such a setup. To assure no interaction with the Delta A mode that might alter the setup, note that some commands are turned off before the setup begins.

There is no SET command.

Response to SET query

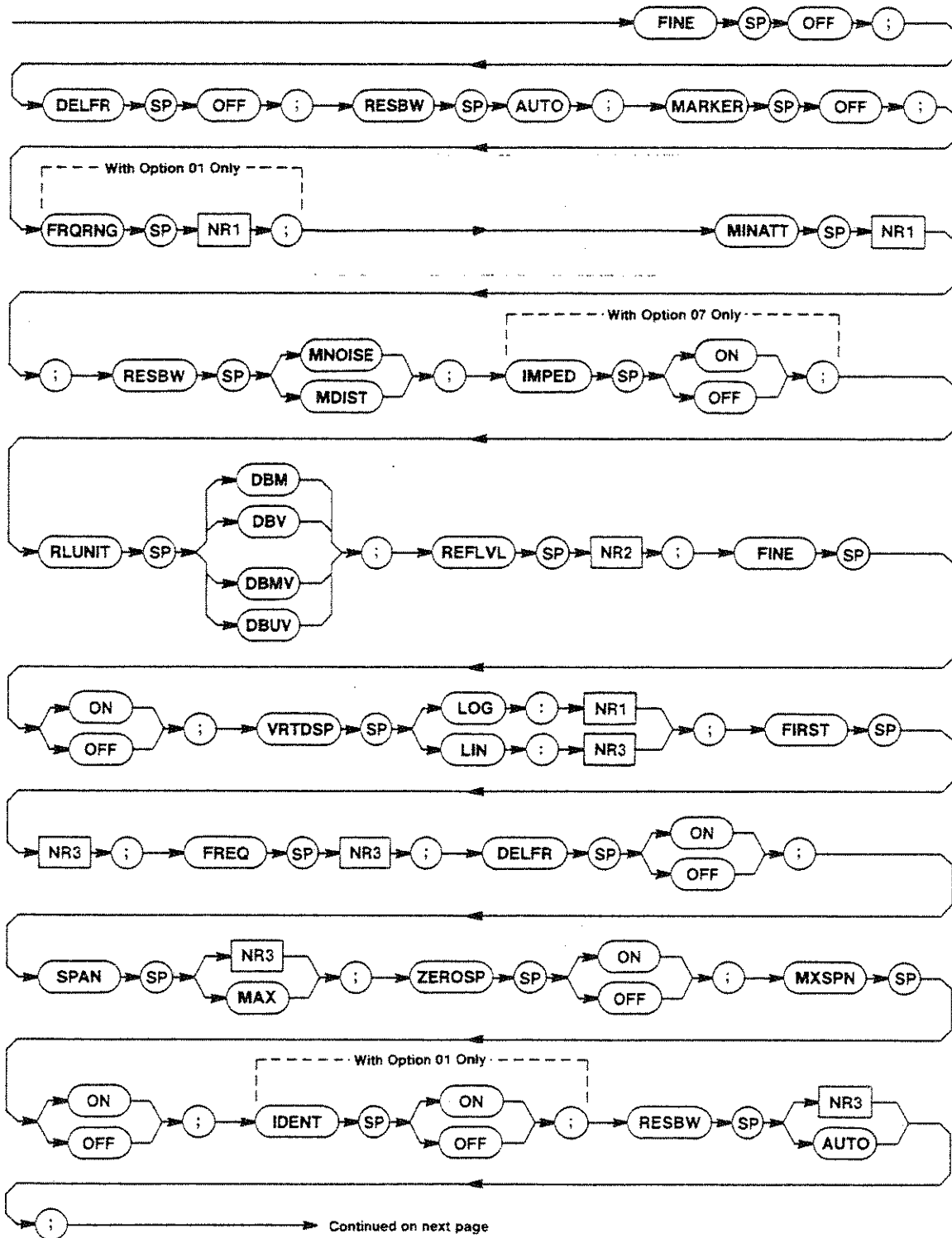

Response to SET query (continued)

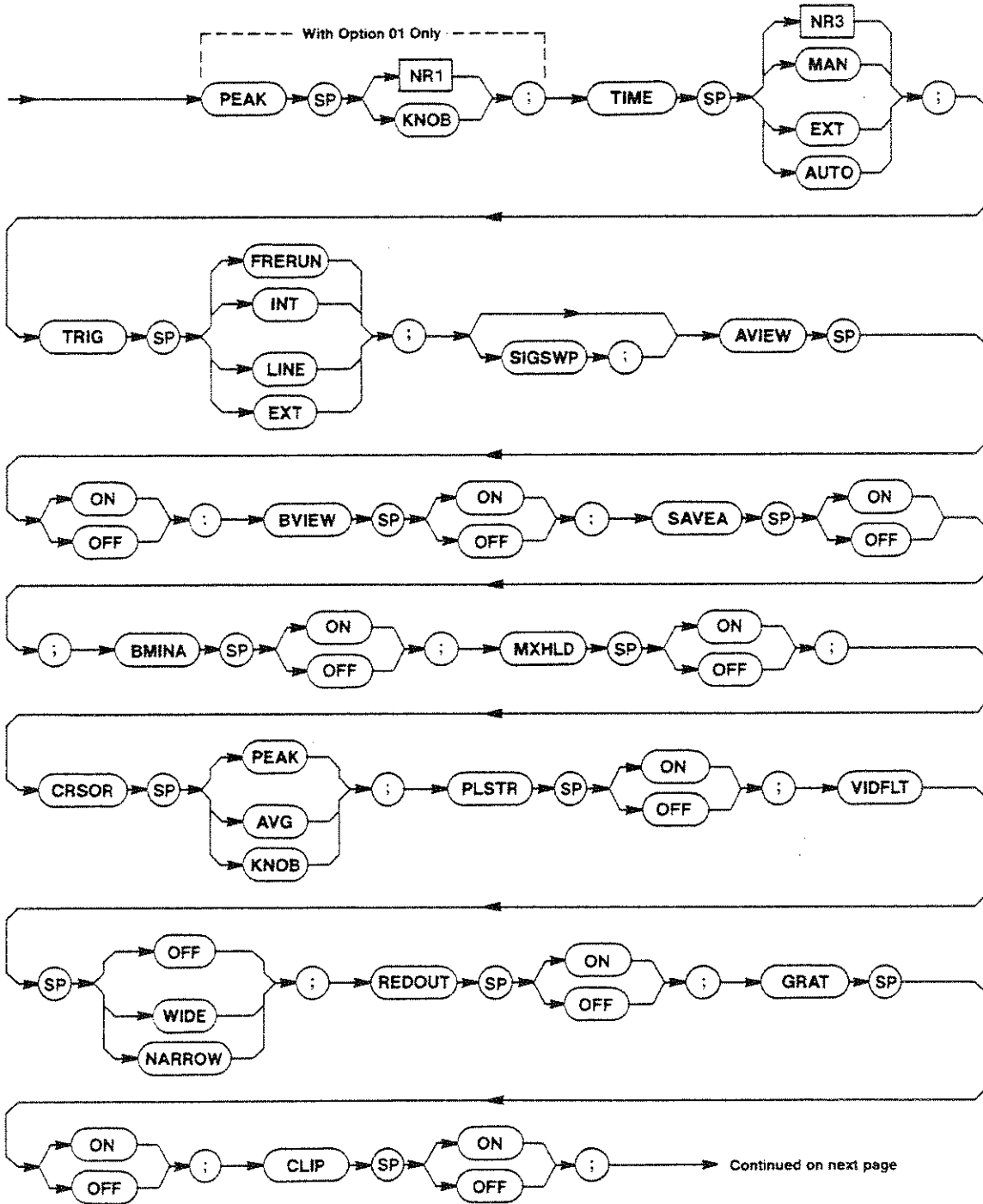

Response to SET query (continued)

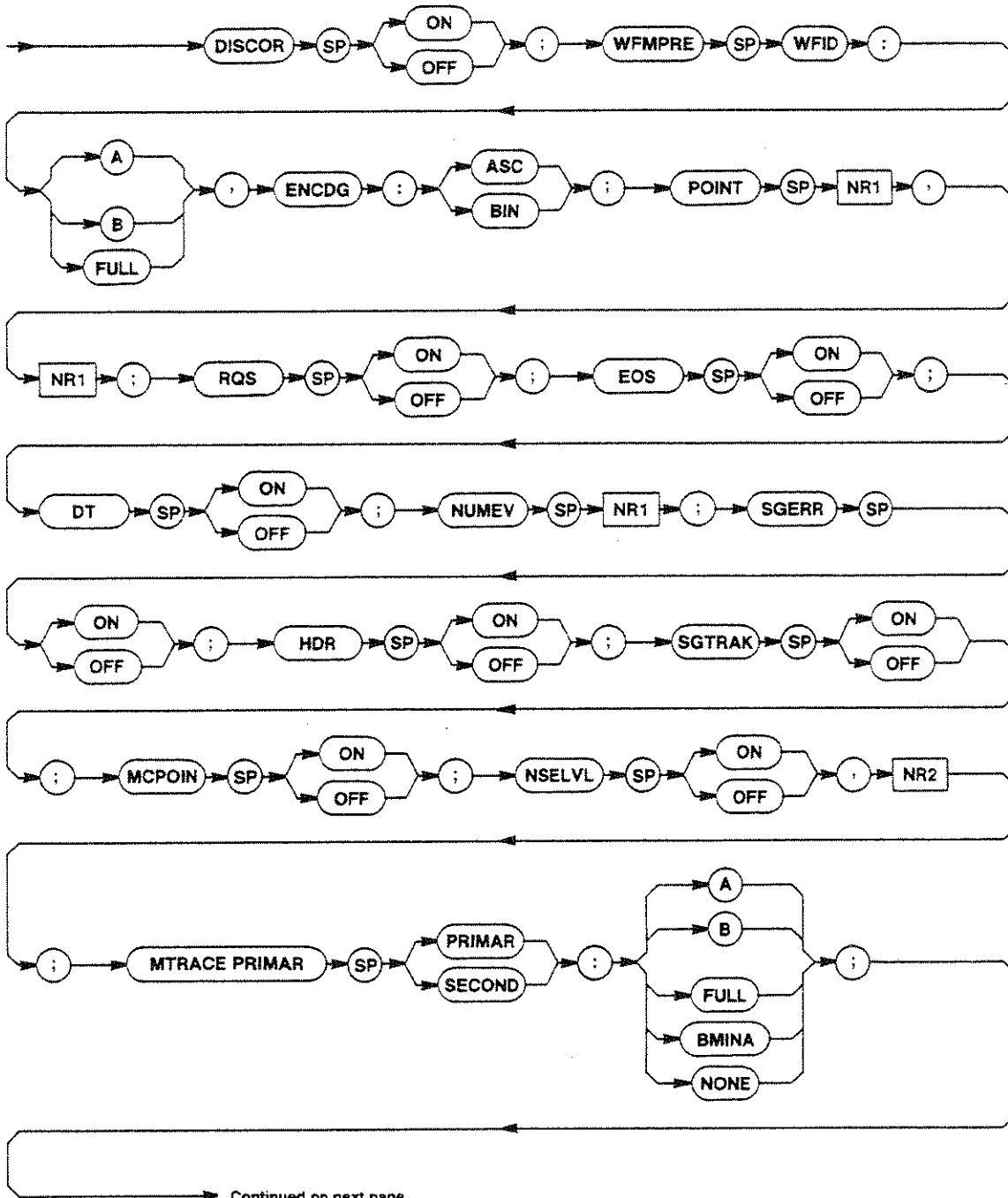

Response to SET query (continued)

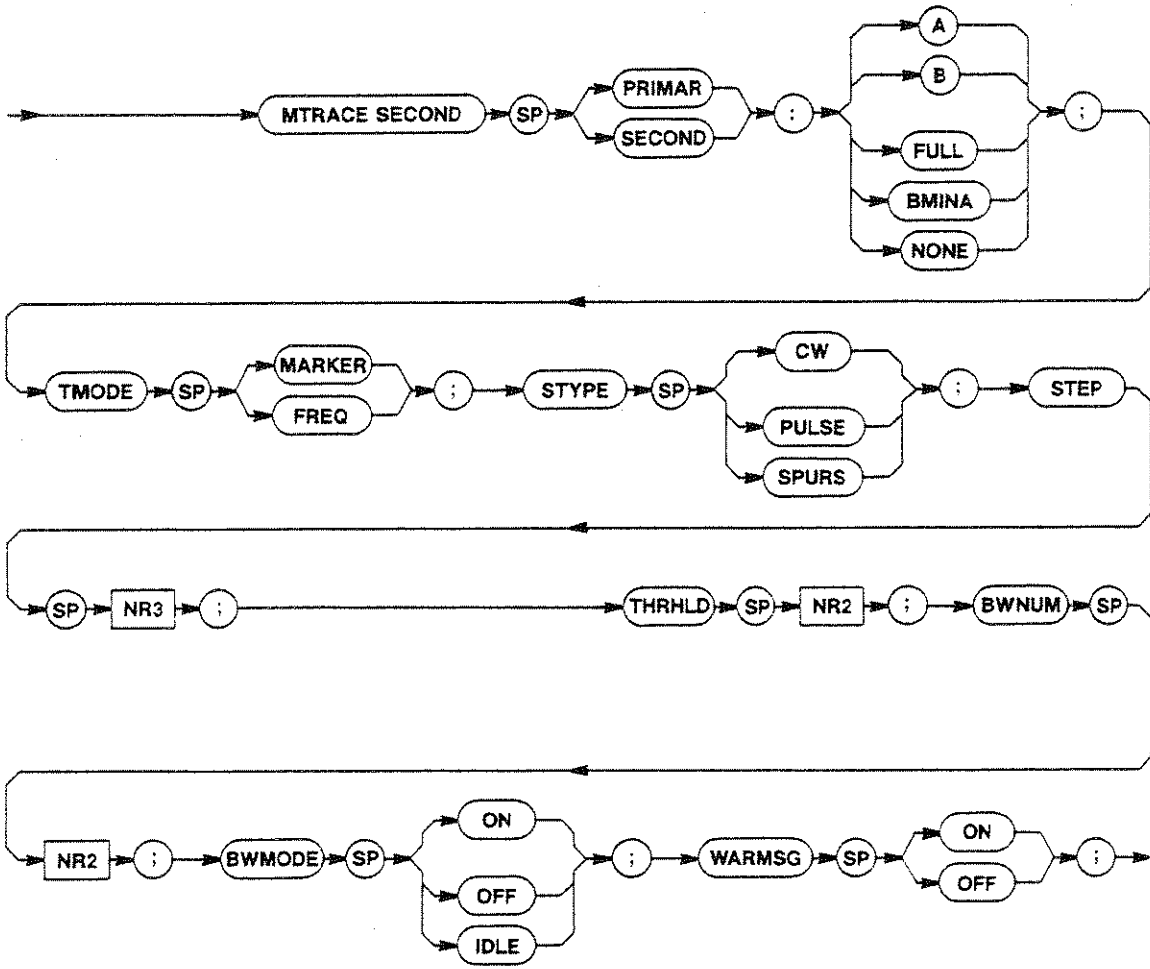

INIT (initialize settings) command

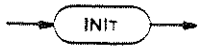

INIT resets the instrument the same as if the power was turned off, then

Interaction — IEEE 488 interface functions are not affected and the instrument remains under remote control. RQS is set to OFF if either the LISTEN ONLY or TALK ONLY switch is set.

There is no INIT query.

ID (identify) query



Response to ID query

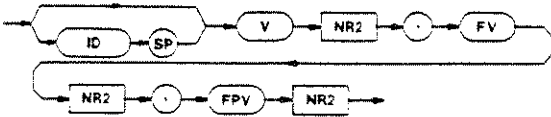

V<NR2> — Tektronix Interface Standard for GPIB Codes, Formats, Conventions, and Features version number.

FV<NR2> — Instrument firmware version number.

FPV<NR2> — Front-panel processor firmware version number.

There is no ID command.

Table 8-1

INSTRUMENT FUNCTIONS	
Mnemonic	INIT Value
FREQ	0
FIRST	4.172E+9
	2.972E+9 — Option 01 Only
SECOND	2.182E+9
DISCOR	OFF
DELFR	OFF
SPAN	MAX
ZEROSP	OFF
RESBW	1 MHz
ARES	ON
MXSPN	OFF
PHSLK	OFF
VIDFLT	OFF
VRTDSP	LOG:10 DB
REFLVL	+30 dBm
CAL	OFF
FINE	OFF
RLMODE	MDIST
PEAK	KNOB
MINATT	Knob position
PLSTR	OFF
TRIG	FRERUN
SIGSWP	OFF
TIME	Knob position
AVIEW	ON
BVIEW	ON
SAVEA	OFF
BMINA	OFF
MXHLD	OFF
CRSOR	KNOB
REDOUT	ON
GRAT	OFF
PT.OFF	500
YOFF	225
CLIP	OFF
TEXT	SHORT
EOS	OFF
RQS	ON
WARMSG	ON
NUMEV	0
IMPED	OFF (50 Ω) — Option 07 Only
RLUNIT	dBm
STSTOP	0–4.2 GHz
	0–1.800 GHz — Option 01 Only
HDR	ON
SGERR	OFF
SGTRAK	OFF
MCPOIN	OFF
NSELVL	OFF
TMODE	FREQ
STYPE	CW
MTRACE PRIMAR	NONE
MTRACE SECOND	NONE
THRHLD	AUTO
BWMODE	OFF

HDR (header) command

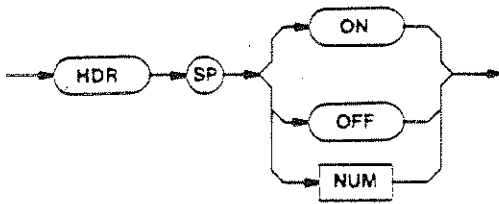

- ON — The header for query responses is turned on.
- OFF — The header for query responses is turned off.
- Power-up value — On.

Interaction — The HDR command has no effect on the SET? response, since the headers are necessary to interpret the response.

HDR (header) query



Response to HDR query

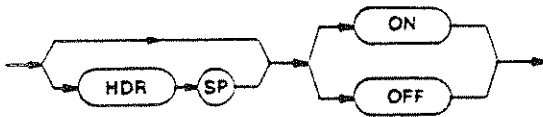

MESSAGE EXECUTION

The two following commands (WAIT and REPEAT) affect how the spectrum analyzer executes message units imbedded within other messages.

WAIT (wait for end of sweep) command

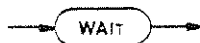

The spectrum analyzer delays action on commands that follow the WAIT command in its input buffer. While the spectrum analyzer waits, it sets its GPIB status byte to busy and does not input device-dependent messages.

The wait condition is ended in either of two ways.

1. WAIT ends if an end-of-sweep is present. If this occurs, the controller is allowed to request updated spectrum data and be guaranteed that the data has been updated. The request message would be similar to

```
SIGSWP;SIGSWP;WAIT;WFMPRE?;CURVE?
```

The first SIGSWP command sets the spectrum analyzer to the single-sweep mode if it was previously in a repetitive-sweep mode. The next SIGSWP arms the sweep, and WAIT delays further action until the sweep completes. The message ends by the request of a waveform preamble and data. (The spectrum analyzer should be triggered or set to FRERUN.)

If the sweep is in the single-sweep mode and is not armed (the READY light is on) when the WAIT command comes up, the spectrum analyzer continues to execute the message in the buffer and does not wait.

2. WAIT is ended if DCL or SDC (while listener-addressed) is received. This empties the input and output buffer so any commands that follow WAIT are stopped. (See STATUS BYTE later in this section.)

Interaction — WAIT delays completion of any portion of a message that follows until one of the ending conditions just outlined occurs.

There is no WAIT query.

REPEAT (repeat execution) command



NUM — This determines the number of times the spectrum analyzer is to repeat the commands or queries that come before REPEAT.

Range — 0 to 16,777,215 (2^[24 - 1]).

Since REPEAT may itself be one of the commands that comes before a REPEAT, the nested (first) REPEAT will only be performed on the first pass through the commands that come before the second REPEAT. For example,

```
RGTNXT;FREQ?;REPEAT 10;FREQ  
15 GHZ;REPEAT 1
```

This causes the spectrum analyzer to output 12 frequency values, because it only performs the frequency query once on its second pass through the entire message.

Interaction — A REPEAT loop can only be stopped by DCL. Pressing RESET TO LOCAL does not stop the loop; it only causes execution error messages to be reported if the loop contains front-panel commands. If RESET TO LOCAL is pressed while a message that includes REPEAT is being acted on, the message will only be repeated 256 times. (Since most commands are ignored after the RESET TO LOCAL button is pressed, the REPEAT loop completes quickly).

STATUS AND ERROR REPORTING

Two commands (EOS and RQS) control spectrum analyzer service requests. STATUS BYTE reports instrument status in a format that includes both IEEE 488 and the Tektronix Interface Standard for GPIB Codes, Formats, Conventions, and Features. GET is enabled to trigger a new sweep (DT), a query (EVENT?) returns detailed information about events reported in the last serial poll status byte, two queries and one command (ALLEV?, NUMEV, EVQTY?) specify the identity and quantity of events reported.

EOS (end-of-sweep) command

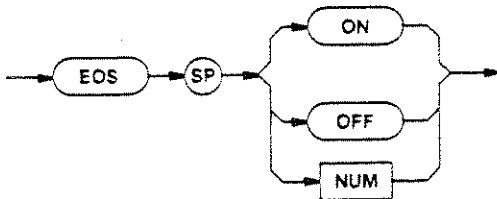

ON — The spectrum analyzer asserts SRQ (if RQS is ON) when a sweep completes.

OFF — The spectrum analyzer does not assert SRQ for the EOS condition.

Power-up value — Off.

Interaction — EOS is always OFF in the talk-only and listen-only modes.

EOS (end-of-sweep) query



Response to EOS query

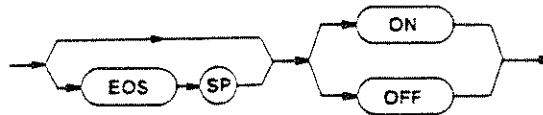

RQS (request service) command

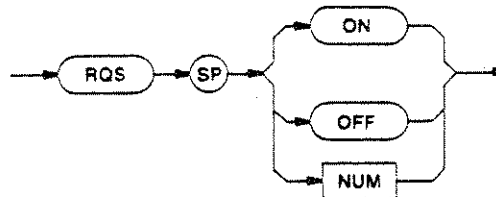

ON — SRQ is asserted when abnormal status conditions occur.

OFF — SRQ is not asserted (is masked) when abnormal status occurs.

Power-up value — On.

Interaction — RQS is always OFF in the talk-only and listen-only modes.

RQS (request service) query

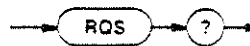

Response to RQS query

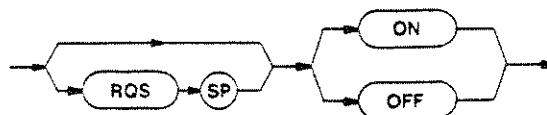

WARMSG (warning message) command

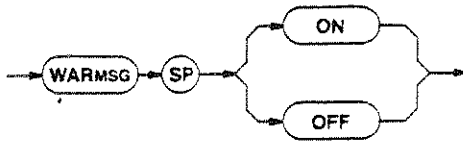

ON — All warning messages will be issued (see Table 8-2).

OFF — No warning messages will be issued (see Table 8-2).

**Table 8-2
WARNING MESSAGES**

Number	Description
Execution Warnings	
50	SPAN defaulted to MAX
52	UNCAL light turned on
53	Multiple use of display buffer
54	UNCAL light turned off
110	STEP size out of range — set to maximum
111	SPAN defaulted to minimum span
Marker Execution Warning	
130	MLFTNX, MRGTNX, MFBIG, HRAMPL, LRAMPL, PKFIND, MVRTDB, or MVLFDDB commands could not find signal

Power-up value — On.

WARMSG (warning message) query



Response to WARMSG query

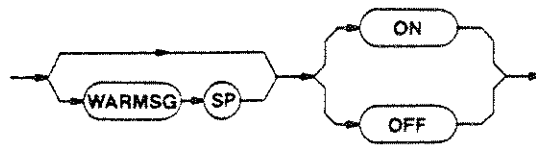

STATUS BYTE (response to serial poll)

When the controller addresses the spectrum analyzer as a talker and sends the SPE (Serial Poll Enable) command, the spectrum analyzer responds by sending its status byte over the bus. The following table explains the messages returned by the spectrum analyzer (1=on, 0=off, X=don't care).

Power-on status — This is set when the instrument is turned on only if an internal switch is set; otherwise, SRQ is not asserted at power-up and power-on status does not exist. If selected by the switch, this status cannot be masked by the RQS command. The instrument is shipped with this switch off. Refer switch selection to qualified service personnel.

End-of-sweep status — This is set when the spectrum analyzer completes a sweep of the selected spectrum; it indicates that digital storage has been updated.

Ordinary operation status — This exists whenever there is no other status condition (nothing out of the ordinary) to report.

Command error — This occurs when a message cannot be analyzed or recognized.

Execution error — This results when a message is analyzed and is recognized, but cannot be executed; such as **FREQ 999GHZ**.

Internal error — This indicates that the spectrum analyzer has discovered a malfunction that could cause the instrument to operate incorrectly.

Execution warning — This results from a command that the spectrum analyzer has performed, but has a potential for error. An example is **RESBW 10 KHZ** in the maximum span mode. The spectrum analyzer sets the warning status because the **UNCAL** indicator is lit.

Internal warning — This reports that a non-fatal operating condition has been detected.

8	7	6	5	4	3	2	1	Decimal	Condition
0	1	0	X	0	0	0	1	65,81	Power on
0	X	0	X	0	0	1	0	2,18,66,82	End of Sweep
0	0	0	X	0	0	0	0	0,16	Ordinary operation
0	X	1	X	0	0	0	1	33,49,97,113	Command error
0	X	1	X	0	0	1	0	34,50,98,114	Execution error
0	X	1	X	0	0	1	1	35,51,99,115	Internal error
0	X	1	X	0	1	0	1	37,53,101,117	Execution error warning
0	X	1	X	0	1	1	0	38,54,102,118	Internal error warning
				--	--	--	--		Four-bit status code
				--	--	--	--		Spectrum analyzer busy condition
				--	--	--	--		Abnormal (1)/normal (0) condition
				--	--	--	--		SRQ is asserted (depends on RQS and EOS commands)

Busy — This is reported whenever the spectrum analyzer acts on a message in its input buffer. This includes the WAIT command; while waiting, the spectrum analyzer reports busy status.

Effect of Busy on Device-Dependent Messages

The spectrum analyzer will not accept further device-dependent messages while the busy condition exists; if made a listener, it asserts NRFD. Commands that require interaction with the hardware can keep the spectrum analyzer busy for a second or more (significant to some bus controllers); for instance, commands such as DEGAUS and INIT. The waveform processing commands and PEAK AUTO can also require significant processor time. Of course, long messages such as the SET? response take a while to execute (see Execution Times, Table 9-2 in Section 9 of this manual). Although output operations such as the CURVE? response may take a long time to complete, the spectrum analyzer is busy only for the time it takes to load the output buffer.

Effect of Busy on Interface Messages

Interface messages and the rtl message from the RESET TO LOCAL button are processed despite busy status. If RESET TO LOCAL interrupts a message, the spectrum analyzer tries to finish the rest of the message after local control is restored. At that time, commands that try to change a front-panel setting will result in error SRQs, because they conflict with local control.

The response of the spectrum analyzer to interface messages depends on how they are handled. Some interface messages are handled by the GPIB interface, while others require action by the spectrum analyzer. The latter generally involve the spectrum analyzer GPIB address and are part of the firmware rather than on the interface. The speed with which these commands can be

handshaked depends on how fast the interrupt can be serviced; which, in most cases, should be within a few hundred micros.

The following apply to interface messages received by the spectrum analyzer.

1. Universal commands LLO, SPE, and SPD are handshaked and acted on by the interface, so they are unaffected by spectrum analyzer activity. The serial poll proceeds without delay if the talk address follows, since this function is handled by the interface.

2. UNL and UNT are handshaked by the interface, which immediately resets the talk or listen function, if active. Addresses that do not match those set by the rear-panel switches are handshaked and discarded by the interface. When the current talk or listen address (MTA or MLA) is decoded by the interface, it holds up the handshake until the spectrum analyzer can get involved. The instrument will get involved as soon as it can service the interrupt. The front-panel ADDRESSED light and the crt readout will be modified as soon as the programs are completed that update the addressed status.

Because the spectrum analyzer gets involved when a current address is received, addressed commands are affected by the speed at which the service interrupts can be handled. Serial poll is similarly affected if MTA preceded SPE.

3. GTL is handshaked immediately by the interface. If the spectrum analyzer is already listen-addressed, the spectrum analyzer returns to local control (executes GTL) after executing any message in its buffer (except WAIT or message units following WAIT). REN unasserted is handled in the same manner as the GTL command.

4. DCL requires spectrum analyzer action that will hold up the handshake if the spectrum analyzer is busy. If the spectrum analyzer is listen-addressed, SDC is treated in the same manner. These two device-clear messages are executed as soon as they are received.

5. GET also requires spectrum analyzer action, so its handshake occurs only when the interrupt can be handled. GET is executed immediately, stopping the current sweep and rearming the sweep.

6. Parallel polls are handled by the spectrum analyzer, so PPC, PPE, PPD, and PPU must wait for the spectrum analyzer to service the interrupts before they can be executed. This assumes that the spectrum analyzer was addressed for the parallel poll sequence.

Busy and end-of-sweep are independent. Busy exists only while the spectrum analyzer is acting on a command, and end-of-sweep indicates that sweep and data-updating are complete. If a single-sweep command is sent, the spectrum analyzer remains busy only until it can start the sweep, while end-of-sweep does not occur until the operation is complete.

When polled, the spectrum analyzer reports a status code related to its SRQ, if any. Bit 5 always indicates the current condition. A serial poll clears the status byte that is reported. Since status is stacked, a new SRQ may be sent immediately.

DT (define triggered events) command

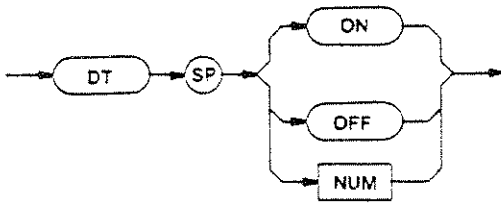

- ON — GET is enabled to trigger a new sweep.
- OFF — The response to GET is disabled.
- Power-up value — On.

DT (define triggered events) query



Response to DT query

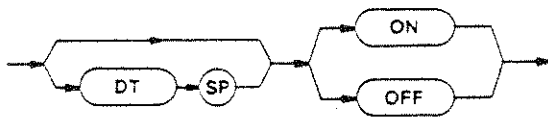

EVENT (event information) query



The EVENT query returns more detailed information about the event reported in the last serial poll status byte. It also allows a controller to get information about events when the device's ability to assert RQS has been turned off (RQS OFF).

Response to EVENT query

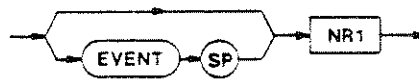

NR1 is an event code defined later in this section in Table 8-4. The EVENT is cleared when the event code is reported.

There is no EVENT command.

ALLEV (all events) query



Response to ALLEV query

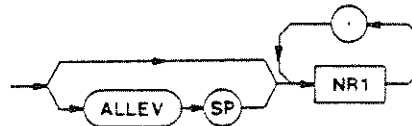

The NR1(s) is the event code defined later in this section in Table 8-4. Events are cleared when their event codes have been reported.

There is no ALLEV command.

NUMEV (number of events) command



NR1 — This specifies the fixed number of event codes is to be returned in ALLEV?. If fewer events are pending when ALLEV? is executed, the response is filled with zeros to provide the specified number. A value of zero sets the spectrum analyzer to return a variable number of event codes. If the number requested is out of range, execution error message 46 will be issued.

Power-up value — 0.

NUMEV (number of events) query

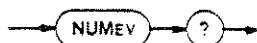

Response to NUMEV query



NUMEV? returns the current value for NUMEV.

EVQTY (event quantity) query



Response to EVQTY query

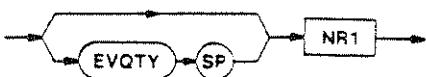

NR1 specifies the number of events that will be returned in the next ALLEV?. If the NUMEV setting is 0 and EVQTY is not executed, ALLEV? returns an unspecified number of events.

There is no EVQTY command.

TEST (internal test) query



This command checks the system ROM and RAM.

Response to TEST query

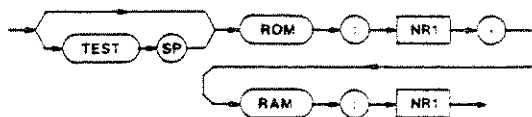

The TEST query response consists of two decimal numbers that indicate if a ROM or RAM IC was found to be defective. These numbers must be translated to their binary equivalents to determine the ROM and RAM locations. (If all ROM and RAM are good, the TEST query response will be ROM:0,RAM:0.) After the binary numbers are determined, put them into the conversion chart in Figure 8-1 to identify the IC number. Then, use Table 8-3 to find the correct circuit number and circuit board. The following example shows how to use the conversion chart and Table 8-3. If any ROM or RAM ICs are indicated to be bad, refer this information to qualified service personnel.

Example — Print #A: "TEST?"
 Input #A: R\$
 Print R\$

If the TEST query response is

TEST ROM:4112,RAM:18

then,

ROM

1. The binary equivalent of the ROM number 4112 is 01000000010000.
2. Insert this binary number in part A of Figure 8-1 (right-justified). Blocks 6 and 2 will be 01. This indicates that both ROM 6 and ROM 2 are bad; all other ROMs are good.
3. Table 8-3 shows that ROM 6 is U2018 and that ROM #2 is U1018; both located on the GPIB board.

RAM

1. The binary equivalent of the RAM number 18 is 10010.
2. Insert this binary number in part B of Figure 8-1 (right-justified). Blocks 5 and 2 each contain a 1, which indicates that both RAMs 5 and 2 are bad; all other RAMs are good.

3. Table 8-3 shows that RAM 5 is U2044 and RAM 2 is U1031; both located on the Memory board.

Table 8-3
TEST CONVERSION

Device	Chart Location	Circuit Board	Circuit Number
ROM	0	A54 Memory	U3060
	1	A56 Memory	U3060
	2	A56 GPIB	U1010
	3	A56 GPIB	U1010
	4	A56 GPIB	U1020
	5	A56 GPIB	U1020
	6	A56 GPIB	U1025
	7	A56 GPIB	U1025
	8	A56 GPIB	U1035
	9	A56 GPIB	U1035
	10	A56 GPIB	U3015
	11	A56 GPIB	U3015
	12	A56 GPIB	U3020
	13	A56 GPIB	U3020
	14	A56 GPIB	U3030
	15	A56 GPIB	U3030
	16	A54 Memory	U3050
17	A54 Memory	U3050	
RAM	1	A54 Memory	U1010
	2	A54 Memory	U3020
	3	A54 Memory	U1030
	4	A54 Memory	U1020

There is no TEST command.

Error Codes

The Tektronix Interface Standard for GPIB Codes, Formats, Conventions, and Features specifies device-dependent Error codes by category. Table 8-4 identifies each general category and lists the codes within that category. Following the listing are the specific error messages returned by the spectrum analyzer. Error codes are returned in numerical order as they appear in Table 8-4. When the current code(s) is read, the error response is cleared.

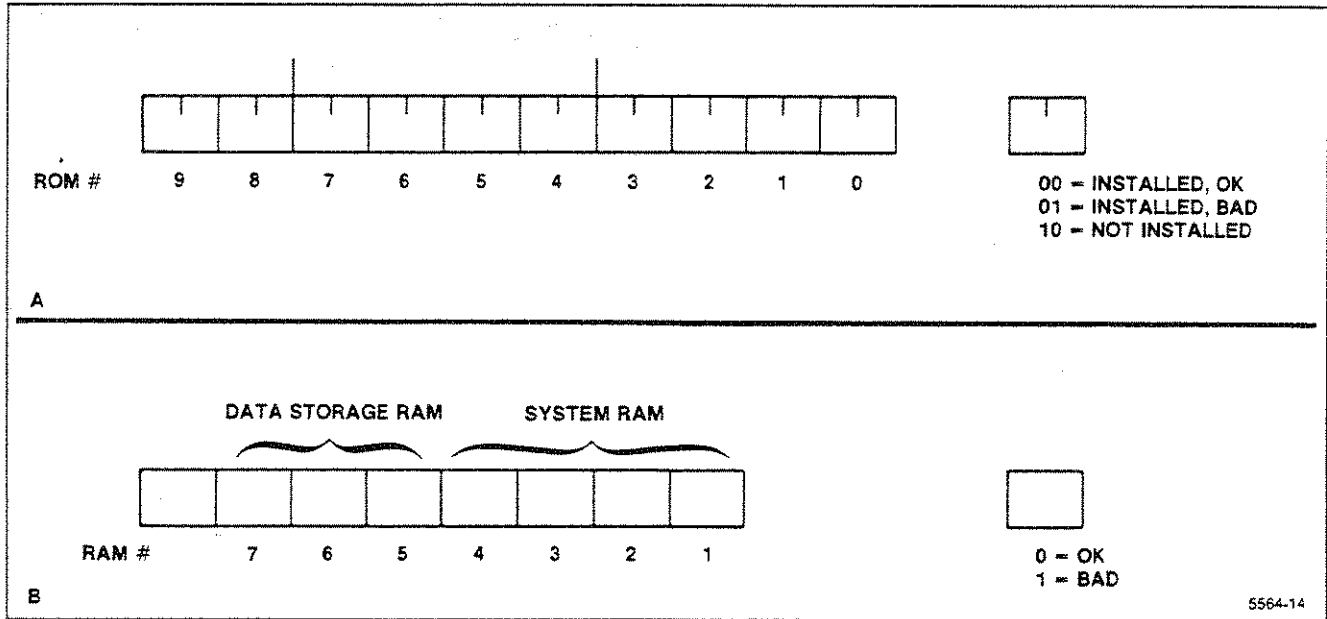

Figure 8-1. TEST Conversion Chart.

Table 8-4
ERROR AND EVENT CODES

ERROR Code	EVENT Code	Meaning
Command Errors		
	101	Command header error
	103	Command argument error
	106	Missing argument
	108	Checksum error
	109	Bytecount error
	150	Input buffer overflow
1	103	Illegal numeric format
4	109	END received in block binary
5	108	Block binary checksum error
6	103	Illegal placement of question mark
7	101	Query not recognized
8	101	Header not recognized
9	106	End of message unit not expected; arguments missing
10	103	Character argument not allowed for this header
11	103	Numeric argument not allowed for this header
12	103	String argument not allowed for this header
13	103	Binary argument not allowed for this header
14	103	Link not allowed for this argument
20	103	Special argument type not recognized
21	103	Special argument not allowed for this header
22	103	Character argument not recognized
24	150	Input buffer overflow
Execution Errors		
	201	Command not executable in Local mode
	204	Settings conflict
	205	Argument out of range
	206	Group Execute Trigger ignored (not executed)
	250	Output buffer overflow: remaining output lost
26	250	Output buffer overflow: remaining output lost
27	201	Attempt to execute command in Local mode
28	205	Frequency out of range (FREQ, TUNE, FIRST, SECOND, MMAX, MMIN, MTUNE, MFREQ, STSTOP, STEP)
29	205	FRQRNG out of range
31	205	SPAN out of range
32	205	RESBW out of range
33	205	MAXPWR or MINATT out of range
34	205	Level out of range (REFLVL, THRHLD, BWNUM, MVRTDB, MVLFDB)
35	205	VRTDSP LIN out of range
36	205	VRTDSP LOG out of range
37	205	TIME out of range
39	204	IDENTify not allowed in this span/div
40	204	Signal finds not allowed in zero span
41	204	Invalid DATA or ADDR argument contents
42	204	DATA direction not compatible with ADDR direction
45	206	GET (Group Execute Trigger) ignored (not executed)
46	205	NUMEV out of range
47	205	STORE, RECALL, DSTORE, or DRECAL out of range
100	403	<SHIFT> SRQ pushbutton was pushed
101	204	Function not available when SGTRAK is on
102	205	Frequency range limited in 75 Ω input — Option 07 only

Table 8-4 (cont)

ERROR Code	EVENT Code	Meaning
Execution Errors (cont)		
103	205	Frequency out of range after step
104	204	Bandwidth mode is not available when in linear
105	205	Illegal sweep range
Execution Warnings		
	551	SPAN defaulted to MAX
	553	UNCAL light turned on
	554	UNCAL light turned off
	555	Multiple use of display buffer
	558	Signal find commands could not find a signal (applies to marker commands only)
	560	STEP defaulted to maximum
50	551	SPAN defaulted to MAX
52	553	UNCAL light turned on
53	555	Multiple use of display buffer
54	554	UNCAL light turned off
110	560	STEP size out of range -- set to maximum
111	561	SPAN defaulted to minimum span
Internal Errors		
	302	System error
	350	Tuning DAC carry operation failer
	351	Failed to lock 1st LO
	352	Lost 1st LO lock
	353	Recentering failure on unlocking of 1st LO
	354	Calibration failure
	355	Battery-operated RAM checksum error
	382	1st LO tuning system failed
	383	1st LO tuning system recovered from a failure
	386	2nd LO tuning system failed
	387	2nd LO tuning system recovered from a failure
	388	Phase lock system failed
	389	Phase lock system recovered from a failure
	396	Power supply out of regulation
	397	Power supply regained regulation

Table 8-4 (cont)

ERROR Code	EVENT Code	Meaning
Internal Errors (cont)		
57	350	Tuning DAC carry operation failed
58	351	Failed to lock 1st LO
59	352	Lost 1st LO lock
60	353	Recentering failure on unlocking of 1st LO
61	354	Calibration failure
62	355	Battery-operated RAM checksum error
72	382	1st LO tuning system failed
74	386	2nd LO tuning system failed
75	388	Phase lock system failed
79	396	Power supply out of regulation
82	383	1st LO tuning system recovered from a failure
84	387	2nd LO tuning system recovered from a failure
85	389	Phase lock system recovered from a failure
89	397	Power supply regained regulation
99	302	Unrecognized event occurred
System Events		
	401	Power on
	402	Operation complete
	403	User request
97	401	Power just came on
98	402	Operation complete (end of sweep)
100	403	<SHIFT> SRQ pushbutton was pushed
Marker Execution Errors		
120	205	Frequency out of range because marker is on inactive trace
121	204	Function not available when marker is on an inactive trace
122	204	Function not available when marker is off
123	204	Function not available when delta marker is off
124	204	Function not available in BWMODE
125	204	Function not available when marker is on a B-SAVEA trace
126	204	Function not available when in dB/Hz
Marker Execution Warning		
130	558	MLFTNX, MRGTNX, MFBIG, HRAMPL, LRAMPL, PKFIND, MVRTDB, or MVLTDDB commands could not find signal

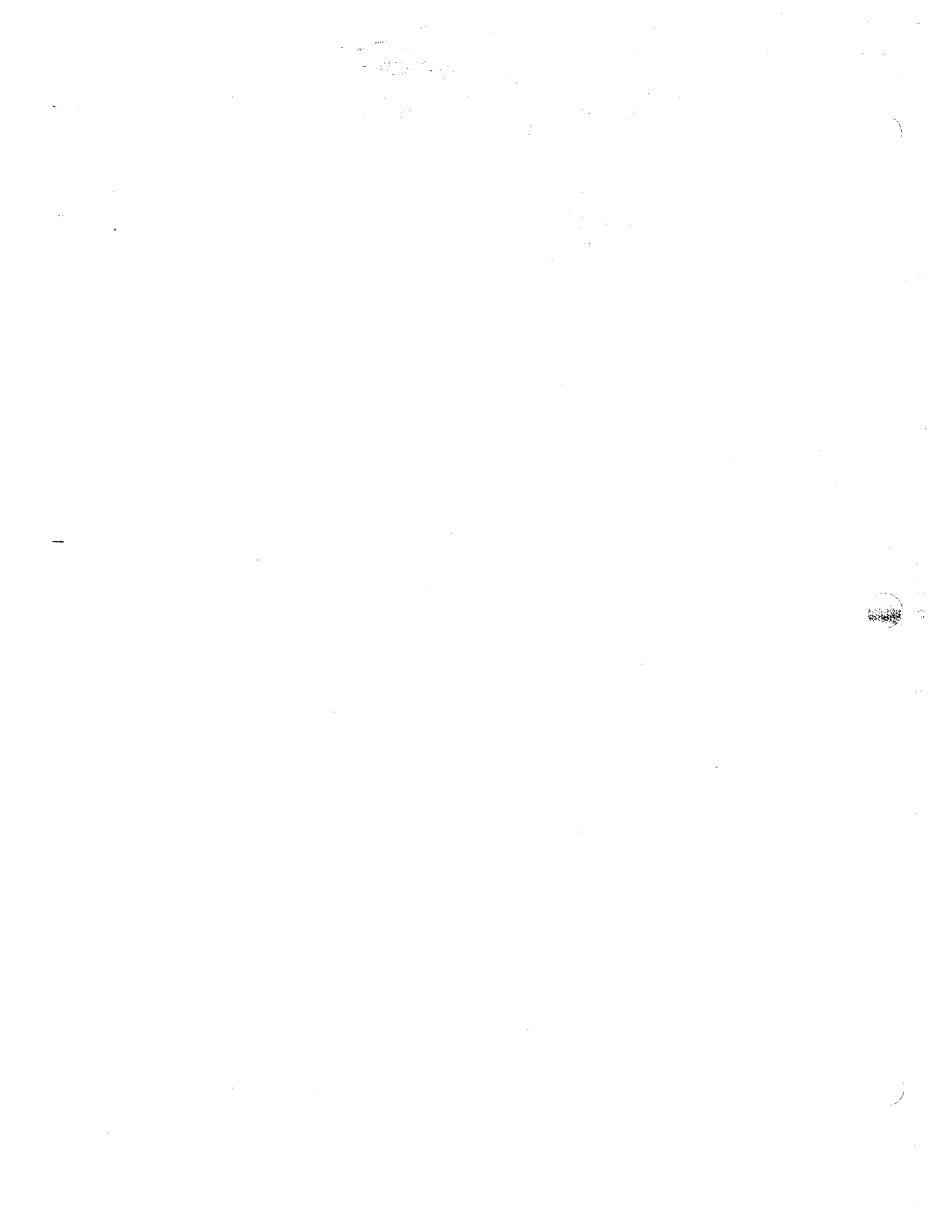

HELPS AND HINTS

This section covers some techniques for programming the spectrum analyzer. This information will speed your progress in putting the spectrum analyzer to work solving your measurement problems.

NOTE

1. In the examples throughout this section, the spectrum analyzer primary address is assumed to be 1. See Section 1 in this manual for how to set the GPIB switches.

2. Some of the lines of input in examples of controller programs in this section extend beyond the column width limitations. Where this occurs, the overrun information is indented on the immediately-following line.

Important — whenever a line is broken, it is always where a natural space occurs. So, be sure to add a space when inputting the program.

PROGRAMMING TECHNIQUES

Signal Processing

The instrument should be in the Single Sweep mode and not be sweeping during any of the signal processing commands or queries. (The signal processing commands are HRAMPL, LRAMPL, MFBIG, MLFTNX, PKFIND, MMAX, MMIN, MRGTNX, MVLFDB, MVRTDB, CURVE, WAVFRM, DPRE, DCOPY, FIBIG, LFTNXT, RGTNXT, FMAX, and FMIN.) If it is sweeping during the command, it will erase the waveform being sent. If it is sweeping during the query, it could give erroneous information.

Wrong Way — The following is an unsuccessful command line to try to center a signal.

```
INIT;FREQ 100MHZ;SPAN 1MHZ:FMAX;POI?
```

In the preceding example, the spectrum analyzer will not have made a full sweep at 100 MHz frequency and a span of 1 MHz before the FMAX;POI? is executed because there is no WAIT included in the command, and you don't know where the sweep was when it went to 100 MHz. The following command line is better, but you will still have an error.

```
INIT;FREQ 100MHZ;SPAN 1MHZ;WAIT;FMAX;POI?
```

In this example, you still don't know where the sweep was when it went to 100 MHz; the screen may not have been updated. The WAIT will tell the spectrum analyzer to wait for the end of the sweep before looking for the maximum point (FMAX). The sweep may not have swept the full 10 divisions with a span of 1 MHz and a center frequency of 100 MHz.

Right Way — In order to satisfactorily center a given signal, be sure to incorporate the SIGSWP command in your program, as in the following example.

```
INIT;FREQ 100M;SPAN 1M;SIG;SIG;WAI;FMA;POI?
```

In this example, the first SIGSWP puts the spectrum analyzer into the Single Sweep mode. The second SIGSWP starts a sweep, and the WAIT tells the spectrum analyzer to wait for the sweep to end before executing the FMA;POI? commands.

DATA ACQUISITION

When the spectrum analyzer receives spectrum data under program control, there are two programs running, not just one. One program is running in the controller and a second in the spectrum analyzer. The key to success is synchronizing the execution of the two programs.

In addition, the two programs must be synchronized with the data acquisition event; in this case, the sweep.

Synchronizing Controller and Spectrum Analyzer

Programs must run in the controller at the same time that the spectrum analyzer acts on messages that come over the GPIB. This is all done within the spectrum analyzer by the way it buffers and executes messages.

When the spectrum analyzer receives a message, it waits until the end of the message to begin acting on it. While busy acting on the message, the spectrum analyzer does not accept any other device-dependent messages. When it is finished with the message, the spectrum analyzer is ready to handshake another message, which it then acts on, and so forth. You can depend on the spectrum analyzer to assert NRFD on the GPIB while it is busy; this prevents a controller GPIB output statement that would send further instructions to the spectrum analyzer.

For example, enter

```
80 Z=1 ! ADDRESS OF SPECTRUM ANALYZER
100 For i=1 to 10
110 Print #z:"FREQ ";i;"GHZ"
120 Next i
```

Watch the spectrum analyzer FREQUENCY readout change while this loop is executing. You can see that the controller executes the loop more slowly than it would if line 110 only printed what is in quotes on the controller crt. What is making the controller step through the loop at a more deliberate pace? It must wait at line 110 for the spectrum analyzer to execute the previous FREQ command.

A controller GPIB input statement can also be used to synchronize the controller and the spectrum analyzer. The controller could make a table of frequency ranges for the frequencies covered by the previous loop, filling the table only after the FREQ command is executed.

```

80 Z=1 ! ADDRESS OF SPECTRUM ANALYZER
100 Dim f(10,2)
110 For i=1 to 10
120 Print #z:"FREQ ";i;"GHZ;FRQRNG?"
130 Input #Z:f(i,1)
140 f(i,2)=i*1E+9
150 Next i

```

Line 130 — Addresses the spectrum analyzer to talk; however, the spectrum analyzer does not begin talking until it finishes executing the message in line 120. This assures that the spectrum analyzer updates the FRQRNG query response before handshaking out array element f(i,1) in line 130.

Synchronizing with the Sweep

Spectrum data can be acquired synchronously with the sweep that updates digital storage if a WAIT command is inserted in the message to the spectrum analyzer. Generally, WAIT is placed immediately after a SIGSWP command that arms a sweep so that data is acquired from a full sweep. WAIT delays the execution of commands or queries that follow in the same message until the full sweep is completed. This means you can direct the spectrum analyzer to acquire, process, and output data, all in the same message. If the commands or queries you add to process or output data follow WAIT, the results will be based on data acquired by the SIGSWP command.

For example, enter

```

80 Z=1 ! ADDRESS OF SPECTRUM ANALYZER
90 Open #z:"GPIB(PRI="&str$(z)&","
EOM=<0>,TIM=100)"
100 Dim p(5,2>)
110 Print #z:"SIGSWP"
120 For i=1 to 5
130 Print #z:"FREQ
";i;"GHZ;SIGSWP;WAIT;FMAX;POINT?"
140 Input #z:p(i,1),p(i,2)
150 Next i

```

Line 110 — Sets the spectrum analyzer to the single-sweep mode (if the spectrum analyzer is not already in the single-sweep mode). Succeeding SIGSWP commands arm the sweep.

Line 130 — Illustrates how to use WAIT. WAIT follows SIGSWP and precedes the command and query that ready the spectrum analyzer to output the updated data. The spectrum analyzer does not handshake out the data in line 140 until it finishes executing the message in line 130.

This simple routine only gets the X variable of the display data point. In this case, it is the horizontal location of the point with the largest value in digital storage. The Y variable is lost each time through the loop when the spectrum analyzer receives further input before it can handshake out the second POINT argument.

Figure 9-1 further illustrates the two-program concept (one in the controller and one in the spectrum analyzer) and how they are synchronized with the sweep for data acquisition. This figure charts the execution of the two programs; arrows between the programs relate how one waits for the other. The WAIT command is executed in the loop that tests for the end of sweep; this synchronizes data acquisition with the sweep.

Using the End-of-Sweep SRQ

Although the previous method for synchronizing controller/spectrum analyzer execution with the sweep is recommended, there is another method. This alternative may be necessary for some operating systems or application programs that allow a short response time when the spectrum analyzer is made a talker or that must take care of other tasks while the spectrum analyzer is acquiring data. In such cases, the controller can enable the spectrum analyzer end-of-sweep SRQ to synchronize data acquisition with the sweep. The following example just shifts the WAIT from the spectrum analyzer program to the 4041 BASIC program to exercise the SRQ. It could be modified, however, to busy the controller with some other task, using the SRQ subroutine to test the status byte and perform input when end-of-sweep status is detected.

```

80 Z=1 ! ADDRESS OF SPECTRUM ANALYZER
90 Open #z:"GPIB(PRI="&str$(z)&","
EOM=<0>,TIM=100):"
100 Dim p(5,2)
110 On srq then call srq_hndl
120 Enable srq
130 Print #z:"SIGSWP;EOS ON"
140 For i=1 to 5
150 Print #z:FREQ ";i;"GHZ;SIGSWP"
160 Wait
170 Print #z:"FMAX;POINT?"
180 Input #z:p(i,1),p(i,2)
190 Next i

```

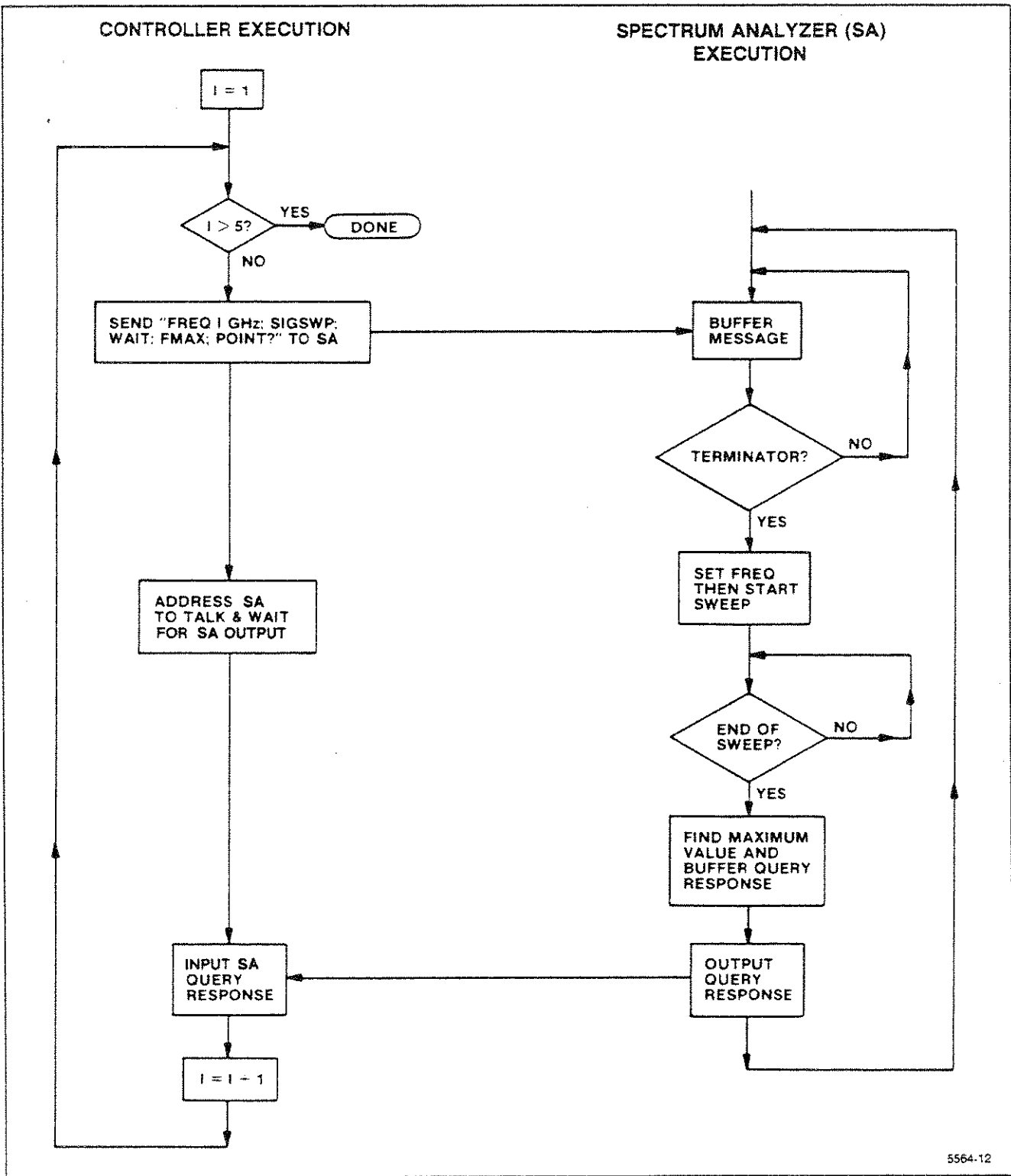

Figure 9-1. Synchronizing controller and spectrum analyzer for data acquisition.

```

200 End
300 Sub srq_hndl
310 Integer status,adr
320 Poll status,adr;z
330 Resume
340 End
    
```

With no WAIT command following SIGSWP in line 150, the spectrum analyzer is ready to buffer another message. But, the controller does not send it immediately because of the WAIT statement in line 160. The SRQ that the spectrum analyzer asserts at the end of its sweep, which was enabled in line 130, triggers the controller to perform a serial poll (lines 300 through 340) and then send the message in line 170.

INPUT: An SRQ Alternative

An INPUT statement in the right place is an alternative to waiting for an end-of-sweep SRQ. This tactic takes advantage of a spectrum analyzer output feature; if the analyzer has no output when it receives its talk address, it outputs a byte with all bits set to one (as soon as it is not busy).

```

80 Z=1 ! ADDRESS OF SPECTRUM ANALYZER
90 Open #z:"GPIB(PRI="&str$(z)&",
EOM=<0>,TIM=100):"
100 Dim p(5,2)
110 Print #z:"SIGSWP"
120 For i=1 to 5
130 Print #z:"FREQ ";i;"GHZ;SIGSWP;WAIT"
140 Input #z:d$
150 Print #z:"fmax;poi?"
160 Input #z:p(i,1),p(i,2)
170 Next i
180 End
    
```

Here the WAIT is put back into the spectrum analyzer message and the INPUT statement in line 140 stalls the controller while the spectrum analyzer makes a sweep. d\$ serves the purpose of a dummy string; the data is not input until line 160.

BINARY WAVEFORM TRANSFER

Selecting binary, rather than ASCII-coded decimal, speeds up waveform transfers. Neither the controller nor the spectrum analyzer has to perform a conversion between binary and ASCII. The difference is evident in the times for both kinds of transfer, listed in this section under Execution Times, Table 9-1. The gains possible by using binary are not hard to achieve. Here's how.

Getting Spectrum Analyzer Binary Curve Output

The spectrum analyzer encloses binary waveform data values in some other items in the binary block format. For details, see the syntax diagrams in Section 6.

For a 4041 routine that handles block binary, enter the following.

```

80 Z=1 ! ADDRESS OF SPECTRUM ANALYZER
90 Open #z:"GPIB(PRI="&str$(z)&",
EOM=<0>,TIM=100):"
500 ! GET SPECTRUM ANALYZER CURVE OUTPUT
510 Integer w(1000) ! Declare integer
array
520 Print #z:"WFMPRE ENC:BIN
530 Input prompt "CURVE?" using
"FA,+8%"dels "," #z:header$,w
540 ! Waveform heading is in header$,
data in w array
    
```

Line 510 — Declares an integer array large enough for a full 1000 points.

Line 520 — Requests the spectrum analyzer to format data in a binary format.

Line 530 — Uses the input prompt to request a curve. The free field input for the header string is delimited from the data a comma with the dels clause, and enters the array w in an 8-bit word format with the image specifier (+8%). The byte count words and checksum are input and checked automatically. Checksum failure results in a trapable error interrupt to the 4041.

Sending a Binary CURVE to the Spectrum Analyzer

The following routine employs end block format to transfer a waveform to the spectrum analyzer. Array w is transferred; if not already created by the preceding routine, w should be dimensioned to 1000 and filled with data in the range 0 to 255.

```

80 Z=1 ! ADDRESS OF SPECTRUM ANALYZER
600 ! TRANSMIT A BINARY CURVE TO THE
SPECTRUM ANALYZER
610 Print using "+8@" #z:w
    
```

Line 610 — Sends the image specifier +8@ followed by the binary numbers in array w, after which it asserts EOI. EOI causes the spectrum analyzer to act on the message. The CURVE header is omitted; it is not required, but would be accepted if sent. The spectrum analyzer buffers the last byte (hex FF), but does not put it into digital storage.

SCALING, SAVING, AND GRAPHING WAVEFORM DATA

The spectrum analyzer waveform data output numbers from 0 to 255 (called screen units). These numbers can be scaled to electrical units using data contained in the WFMPRE response.

Here is an expanded version of the spectrum analyzer binary output program given above. This version transfers whatever portion of memory you have previously specified with a WFMPRE command: A, B, or FULL (power-up default is FULL). The program scales both the X and Y values and stores them in a two-wide array. The program also saves the n-scaled binary array so you can transfer it back into spectrum analyzer digital storage if you wish.

```
100 ! GET AND SCALE SPECTRUM ANALYZER
    BINARY CURVE OUTPUT
110  Delete var w,m
120  Print #1:"WFMPRE?"
130  Input dein "" #1:n,x3,x2,x2,y3,y2,y1
140  Goto 150
150  Dim m(n,2)
160  Integer w(n)
170  Gosub wave_in
180  Got i=1 to n
190   M(i,1)=x1+x2*(i-1-x3)
200   M(i,2)=y1+y2*(w(i)-y3)
210  Next i
220  Stop
230  Wave_in: print #z:"WFM ENC:BIN"
240  Input prompt "CURV?" using "FA,+8% dels ",
    #z:head$,w
250  Return
```

Line 110 — Clears the waveform arrays.

Line 120 — Requests the waveform preamble and a binary curve.

Line 130 — Inputs the spectrum analyzer WFMPRE response, storing the first seven numbers it finds as variables n, x3, x2, etc.

Lines 150 and 160 — Calls subroutine wave_in to put the waveform in w.

Lines 180-220 — Scales the waveform integers and fills array m with the result. The first number in each element of the array is a frequency, and the second number is the power detected at that frequency. The elements can be printed on the screen with the statement PRINT M, or any element i can be printed with the statement PRINT M(i).

Lines 230 and 240 — Uses the input prompt to request a curve. The fre field input for the header string is delimited from the data by a comma (,) with the dels clause, and enters the array W in an 8-bit word format with the image specifier (+8%). The byte count words and checksum are input and checked automatically.

Checksum failure results in a trapable error interrupt to the 4041.

Saving the Scaled Array

A single statement (WRITE) transfers an array to tape. First, however, you must find and mark an adequate tape file. These statements do the job (insert the number of the last tape file for N).

```
FIND N
MARK 1,20000
FIND N
WRITE #33:M
```

These statements return the data from the tape.

```
FIND N
READ #33:M
```

Storing Settings

If a particular series of settings are commonly used in an application, it is recommended that these settings be stored within the spectrum analyzer using the STORE command. This practice will save program storage in the controller, programming time, and bus transfer time. The settings can be recalled whenever needed with the RECALL command.

Using PLOT

The spectrum analyzer can generate a plot of the display directly on a Tektronix 4662 Option 01, 4662 Option 31, or a 4663 (in the 4662 emulation mode) plotter; a Hewlett-Packard HP7470A, HP7475A, HP7580B, HP7585B, or HP7486B plotter; or a Gould 6310 or 6320 plotter. All selected waveform, graticule, marker, and crt readout data can be plotted. PLOT? sent to the spectrum analyzer causes it to output the plotter code when addressed as a talker. Address the plotter as a listener, then monitor the EOI line to allow the controller to cause a plot to be generated. The following routine assumes the spectrum analyzer is at address z, the plotter is at address P, and that the plotter type has been selected with the <SHIFT> PTYPE command.

```
80  Z=1 ! ADDRESS OF SPECTRUM ANALYZER
100  Print #z:"GRAT ON;RDOUT ON;PLOT?"
110  WBYTE ATN (64+2.32+p)
120  On EOI (2) then gosub 200
200  WBYTE ATN (unl,unt)
210  Resume
```

Line 100 — Illuminates the graticule, turns the crt readout on, and readies the spectrum analyzer to send a waveform to the plotter.

Line 110 — Makes the spectrum analyzer a talker and the plotter a listener.

Line 200 — Untalks the spectrum analyzer and unlistens the plotter.

WAVFRM
DPRE
DCOPY
SGTYPE
BWMODE

MULTIPLE USE OF DISPLAY BUFFER

An error message alerts you to possibly invalid data caused by multiple use of the display buffer; that is, using the buffer for more than one purpose during execution of a message. Also, you are informed in this manual of possible interaction involving waveform processing and waveform data I/O executed in the same spectrum analyzer message. (This occurs in Section 6 under the interaction part of the CURVE command and under Display Data Point Commands Interaction in Section 7).

There is no conflict in many cases because the spectrum analyzer buffers the message you send and then executes it in the order you sent it.

For example, you can use the spectrum analyzer as a waveform processor for spectrum data you previously acquired in array A by entering

```
80 Z=1 ! ADDRESS OF SPECTRUM ANALYZER
100 ! BUFFER DEMO
110 Print #z:"CURVE ";a,";FIBIG:POINT?"
120 Input #z:B1,B2
```

In this case, the spectrum analyzer does what you ask; it loads a waveform into digital storage and returns the point at the peak of the largest signal.

Interaction is possible in other cases, however, because there is only one display data buffer used for both display input and output and as workspace for waveform processing. For instance, conflicts can arise when more than one of the following message units is executed in the same message.

CURVE
CURVE?
POINT (if Y argument omitted)
FIBIG
LFTNXT
RGTNXT
FMAX
FMIN
HRAMPL
LRAMPL
MFBIG
MLFTNX
PKFIND
MMAX
MMIN
MRGTNX
MVLFDB
MVRTDB

Whether interaction results in invalid data depends on the relative position of these message units in the message. This follows from how these message units use the buffer.

Buffer Data Flow

Data flow through the buffer is diagrammed in Figure 9-2. This figure identifies the kinds of data operations as data paths or destinations branching from the right of the buffer. The partitions in digital storage memory are shown as data sources or destinations branching from the left of the buffer.

The WFMPRE and CURVE commands contain arguments that set switches to control data flow through the buffer. Either the CRVID argument or the WFID argument sets the switch to select A, B, or FULL (A and B) memory. The ENCDG argument sets the switch that selects either ASCII or block binary waveform output. Both switches are shown in their power-up default positions. They remain wherever they are set until changed by an appropriate command.

Order-Dependent Conflicts

Conflicts in the use of the buffer occur depending on the order in which waveform processing and I/O occurs. The CURVE query and display data point commands, by contrast, simultaneously load the buffer as they execute. The CURVE command transfers the data to digital storage while executing, and the display data point commands act on the data while executing. The CURVE query, by contrast, does not transfer the data until after the entire message is executed (and the spectrum analyzer receives its talk address). Thus, if these message units are mixed in a message, the contents of the buffer may be changed between when it is loaded and when it is acted on or transferred.

```
80 Z=1 ! ADDRESS OF SPECTRUM ANALYZER
90 Open #z:"GPIB(PRI="&str$(z)&","
EOM=<0>,TIM=100):"
100 ! Waveform processing and I/O
110 Dim b(1000)
120 Print #z:"CURVE?"
130 Input #z:b
140 Print #z:"CURVE ";A;
150 End
```

Line 120 — Requests a curve, which the spectrum analyzer buffers.

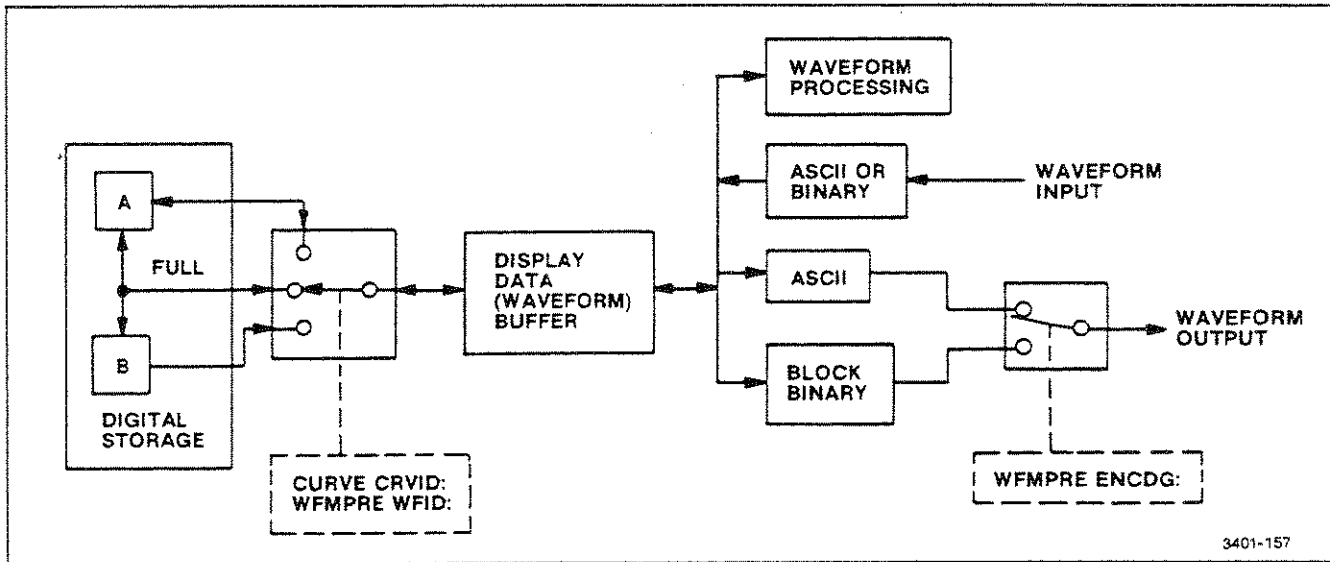

Figure 9-2. How multiple use of the display data buffer is controlled.

Line 130 — Inputs the curve before it is overwritten by line 140. The semicolons enclosing A at the end of line 140 instruct the controller to squeeze out unneeded spaces between the numbers as the PRINT statement transmits array A. Without a semicolon immediately after the array variable, this line does not run properly. With this semicolon, the controller places a space between numbers; the spectrum analyzer accepts the space (or other format characters), as well as a comma, for a delimiter.

FINDING SIGNALS WITH WAVEFORM PROCESSING

The waveform processing functions in the spectrum analyzer allow many waveform parameters to be found without transferring a waveform to the controller. You will get better results if you understand how the routines work and what their limitations are. This portion of the manual will try to help you gain that understanding and to use the power of the spectrum analyzer in your application with more accurate and predictable results.

Understanding How Waveform Processing Works

There are two sets of signal processing commands; commands that move the marker and commands that move the display data point. (See Sections 5 and 7 of this manual for more information.) Each set of commands uses a different signal-finding algorithm. Commands that move the display data point use the same algorithm as the commands used in previous 490-series spectrum

analyzers. This algorithm looks for the signal shape produced by a continuous wave (cw) signal passing through the resolution filters of the spectrum analyzer. Complex spectra, such as those produced by amplitude, frequency, or pulse modulation or by signals with significant amounts of drift or phase noise, may be missed.

In contrast, the marker-related signal processing commands allow, through the STYPE command, a choice of signal-processing algorithms. These commands identify a "candidate" signal by means of three points; a peak and a point 3 dB down on each side of the peak. Whether or not the candidate is recognized as a signal depends upon the processing mode chosen. When SPURS is chosen, all candidates are taken to be signals. When CW is chosen, a signal (to be a signal) must be at least half as wide as would be predicted from the resolution filter in use. (Note that this is not the same algorithm as the one used by the data-point-related commands. In particular, the data-point algorithm looks for a particular width, while the marker-related algorithm looks only for a minimum width. Note also that if the span is wide in comparison with the resolution bandwidth, there may be no difference between SPURS and CW.) When PULSE is chosen, if two candidate signals are within two minor divisions (0.4 of a major division), they are assumed to be either time-related lines or spectral lines belonging to the same pulse. This extends to multiple lines; in a group of such lines, the highest-amplitude line will be identified as the center of the signal.

Another difference between the display-point commands and the marker commands is the output units. The POI? query reports in screen units; 1-1000 horizontally and 25-225 vertically. The marker queries report the actual frequency and amplitude of the marker.

Two other factors affect the results. The first of these is separation. With any of the signal-processing commands, there must be at least a 3 dB "notch" between two signals in order for them to be individually recognized. The second factor is noise. Because noise is random, noise peaks may appear to be small signals. Whether or not these peaks are detected may be controlled by using a threshold with the signal-processing commands. This is discussed in the following description.

After a signal is found, it is often moved to center screen and to the reference level with either the CENSIG or TOPSIG commands (for the display-point-related functions). The accuracy of the vertical display and the reference level determine how closely the point of interest can be moved to the reference level. For CENSIG, and for MCEN on a saved or stored trace, the span/division determines how closely the point of interest can be moved to center screen. On an active trace, the oscillator frequencies are counted at the marker, and the values are used to set the center frequency for the MCEN command. Thus, on an active trace, MCEN will generally be more accurate than CENSIG. These commands may be applied repetitively for greater accuracy.

Setting the Threshold

Both sets of signal-finding commands use a threshold that may be set above the noise and below the signal level so that small noise peaks will not be falsely identified as signals. The threshold for the display-point commands is sent in screen units as an optional argument to the commands. The threshold for the marker commands is set in dBm (or dBv, dBmv, or dB μ v) by the THRHL command.

No signal threshold setting will work in every case. An estimate of the noise level may be made by finding the amplitude of the negative noise peaks with FMIN (or MMIN) and adding a constant to get an estimate of the positive noise peaks. Because the peak-to-peak noise variation is a function of resolution bandwidth, the constant should be larger for wide bandwidths than for narrow bandwidths. Alternatively, the positive peak noise level can be found directly with FMAX (or MMAX) if all signals are tuned off the screen.

The value of THRHL can also be set to AUTO. The threshold used for marker-related signal-processing commands will then be set slightly above the expected noise level, as determined by the instrument's sensitivity specification, attenuator setting, resolution bandwidth, and video filter bandwidth. The actual threshold value chosen will be returned in the response to the THRHL query.

Acquiring Data for Waveform Processing

Both the signal separation and the noise considerations mentioned previously need to be addressed when the waveform is acquired, as well as when the signal-processing commands are actually used.

Signal separation can be improved by selecting a narrower resolution with the RESBW command. This may require the sweep to be slowed to maintain amplitude and frequency calibration. (TIME AUTO will automatically maintain a calibrated display, if possible.)

Noise peaks can be reduced by smoothing the data as it is acquired by means of video filters and/or digital averaging. The bandwidths of the wide (VIDFLT WIDE) and narrow (VIDFLT NARROW) video filters are automatically changed in step with the resolution bandwidth.

To use digital averaging, select CRSOR AVG or set the peak/average line above the noise floor and select CRSOR KNOB. Successive samples are averaged to obtain the value displayed at each digital storage point. The number of samples averaged increases as the sweep is slowed. This number is given by (Time/div)/100/9 μ s.

Spectrum Search

To search a given frequency range for signals, set the spectrum analyzer to sweep the given range with FREQ and SPAN or STSTOP. If the frequency range is wide and/or the number of signals expected is large, search the range in sections.

With the marker or display data point at the left edge of the screen, find the lowest frequency signal with the MRGTNX command or the RGTNXT command. Find successive signals by repeating the same command. All signals in the display have been found when the RGTNXT command sets the display data point to 1001,0 or the MRGTNX command generates an SRQ message of NO SIGNAL FOUND. If the service request is disabled, either through SGERR OFF or RQS OFF, the MRGTNX? query can be used to determine whether the MRGTNX command found (FOUND will be returned) or did not find (FAILED will be returned) a signal.

Signal searches should be done in the single-sweep mode; take a new sweep only when all signals in one waveform have been found. If the total range is being searched in sections, move to the next section with a TUNE, FREQ, STSTOP, PSTEP, or MSTEP command and repeat the search.

By positioning the marker or display data point properly at the start of the search, the LFTNXT, MLFTNX, HRAMPL, and LRAMPL commands can also be used to find all signals in a given waveform.

Because the oscillators are counted on an active trace, the marker-related commands are slower on an active trace than on a stored trace. Speed will be increased, at the expense of some accuracy, by turning BVIEW OFF and commanding SAVEA ON after the single sweep and before the search is started. SAVEA OFF should be sent before the next sweep.

A signal search program using RGTNXT is given in connection with the description of the REPEAT command.

Using MCEN

To span down around a signal without having to manually span down, re-center the signal, etc., use the MCEN command after first having selected the desired signal with one of the signal finding commands described previously. Then select the desired span/div.

Higher Center Frequency Drift Rate After Tuning

After a large center frequency change (more than 500 MHz), oscillator drift can cause center frequency errors. This is especially noticeable at slow sweep speeds at spans just above the point where the 1st LO is phase locked (which occurs at either 200 kHz/div or 50 kHz/div, depending upon span). Additional delay time after a large frequency change, beyond that built into the spectrum analyzer firmware, may be needed to reduce the drift rate.

Noise can be overcome in several ways. To reduce noise peaks, smooth the data by averaging in digital storage. Averaging is enabled by the CRSOR command; use CRSOR AVG or CRSOR KNOB and set the cursor above the noise by turning the front-panel knob. Further smoothing is possible by slowing the sweep (TIME command) so that the amount of data averaged for each point in digital storage is increased.

Noise peaks can also be reduced (smoothed) by the video filters. The narrow video filter (VIDFLT NARROW) is recommended for acquiring data for most waveform processing applications.

There is an alternative to smoothing the data. The signal search commands can include a parameter that sets a threshold for the signal search routine. If this parameter is set above the noise, but below any desired signal, the routine ignores the noise and finds the signal. But, how do you find this level that is not too high and not too low? There is no one level that will work in every case. A level may be estimated by using FMIN to locate the negative noise peaks and adding a constant to approximate the positive noise peaks. Adjust the constant if resolution bandwidth is changed. Another method is to force signals off-screen with the FREQ command and use FMAX to acquire the most positive noise peak.

In practice, a combination of these methods may be applied to handle varying conditions. For example, smooth the data with the narrow video filter and average it as it is acquired to enable the search routine to find signals close to the noise floor.

SPECTRUM SEARCH USING REPEAT

The spectrum analyzer can perform a signal search by executing a loop in a single message and buffering the results without controller interaction. The controller can later turn its attention again to the spectrum analyzer and input the results. The following routine works on a waveform in digital storage that is not updated during processing.

```

80  Z=1 ! ADDRESS OF SPECTRUM ANALYZER
100 ! SPECTRUM SEARCH
110  Print #z:"POINT 0"
120  Print #z:"RGTNXT;POINT?;REPEAT 20"
130 ! *****
140 ! INSERT ANY OTHER TASKS
150 ! *****
300  Dim p(20,2)
310  Input #z:p
    
```

Line 120 — The spectrum analyzer buffers the query responses as it executes the loop.

Line 310 — Inputs the signal points as a string, delimited by semicolons.

The number of query responses that can be buffered depends on the query and the message sent to the spectrum analyzer. The buffer can handle 176 (FRE?;REP 175) responses to the FREQ query, which includes the frequency in scientific notation; but, the buffer can handle 293 (PHS?;REP 292) of the shorter PHSK query responses (PHSK ON or PHSK OFF). Messages and responses share buffer space. Long messages will leave less space for responses than short messages.

MESSAGES ON THE CRT USING RDOU

The spectrum analyzer accepts either a single set or a double set of quote marks to delimit the crt message. With the 4041 controller, use single quotes around the message inside the RDOU command.

```

100  Print #z:"RDOU 'SET THE PEAK/AVERAGE CONTROL'"
    
```

This is necessary because the 4041 uses a double set of quotes to set off the message following the colon in the Print statement. A variation gets around this if you want quote marks to appear on the spectrum analyzer crt.

```
100 Print #Z:"RDOUT 'PRESS ""RETURN TO
LOCAL"""
```

The controller strips off the first set in each double set of quote marks and transmits the second set of each double set for the display.

The RDOUT message continues to be displayed if the spectrum analyzer remains under remote control. To demonstrate the above messages by themselves, add the following statement.

```
110 Goto 110
```

To scross the RDOUT message to the top of the spectrum analyzer screen, insert the following statement.

```
105 Print #z:"RDOUT"
```

USING CAL OVER THE BUS

The CAL function activated from the front panel does two things. It directs the operator in the adjustment of the four screwdriver adjustments (AMPL and LOG CAL, and Vertical and Horizontal POSITION). CAL also performs an automatic calibration of the relative amplitude, frequency, and noise bandwidth of the resolution bandwidth filters. The CAL command allows these functions to be separated so that either the adjustments or the automatic calibration will be done.

To recreate the front-panel calibration function over the bus requires that five commands be sent to the instrument; four for the adjustments and one for the automatic calibration. User prompt messages are displayed on the crt screen. Since the spectrum analyzer is in the Remote mode, the controller keyboard must be used to go to the next adjustment step. A device clear is sent to the spectrum analyzer to terminate the execution of each adjustment command. Note that HPOS could be deleted without affecting the other adjustments, but the others should be done in the recommended order. The program must contain a message instructing the operator to connect the calibrator.

```
80 Z=1 ! ADDRESS OF SPECTRUM ANALYZER
90 Open #z:"GPB(PRI="&str$(z)&,"
EOM=<0>,"TIM=100):"
100 Print #z:"RDO 'CONNECT CAL OUT TO RF
INPUT"
110 Print #z:"RDO 'HIT RETURN AFTER
COMPLETING EACH STEP"
120 Input b$
130 Print #z:"CAL AMPL"
140 Input b$
150 WBYTE DCL
160 Print #z:"CAL HPOS"
170 Input b$
180 WBYTE DCL
190 Print #z:"CAL VPOS"
```

```
200 Input b$
210 WBYTE DCL
220 Print #z:"CAL LOG"
230 Input b$
240 WBYTE DCL
250 Print #z:"CAL AUTO"
260 End
```

COMPARING FREQ AND TUNE

The FREQ command argument is in absolute frequency, while the TUNE command argument is in relative frequency. Use FREQ to change the center frequency to some value you supply as a command argument. Use TUNE to change the center frequency by some offset you supply as a command argument.

The ranges of the FREQ and TUNE commands differ in several respects. The range of the FREQ command covers the entire range of the instrument; the appropriate band is automatically selected if the FREQ argument is beyond the range of the current band. The TUNE command is limited to the current band limits.

COMPARING THE STATUS BYTE AND THE ERR? RESPONSE

The spectrum analyzer status byte and ERR? response described in Section 8 play complementary roles in GPIB system programming. The status byte is the spectrum analyzer response to a serial poll. The ERR? response is the spectrum analyzer answer to a device-dependent query message. The status byte provides information about instrument conditions by category; normal/abnormal, busy, command error, execution error, etc. The ERR? response details the cause of abnormal status; i.e., what kind of error or warning prompted the spectrum analyzer to assert SRQ and report abnormal status.

Status bytes are not stacked. The code for the condition that caused the SRQ is not updated, although bit 5 reflects the present instrument state (1 for busy, 0 for not busy). Error codes, however, are accumulated until read and are reported in numerical order. While you can recover only one status byte, you may recover more than one code in the ERR query response, indicating more than one abnormal condition occurred. The status byte is cleared by a serial poll of that instrument. Error codes are cleared by reading them with the ERR query. Reading the status byte does not clear the error codes, and vice versa. DCL and SDC (if addressed) clear both the status byte and error codes.

EXECUTION AND TRANSFER TIMES

The spectrum analyzer firmware typically takes 10 to 25 ms to execute commands received over the bus. This is the time the spectrum analyzer is busy following receipt of the end-of-message terminator (EOI or LF, depending on the switch). Execution time for some commands stretches beyond 25 ms, however, because of interaction between the firmware and hardware or a wait to allow hardware response. These cases are noted in Table 9-1.

Table 9-1
EXECUTION TIMES

Command	Time
FREQ, MFREQ 0-1.8 GHz @ 10 MHz/div 100 MHz step @ 10 MHz/div	800 ms
0-1.8 GHz @ 1 MHz/div 100 MHz step @ 1 MHz/div	150 ms
TUNE, MTUNE 100 kHz step @ 100 kHz/div 100 Hz step @ 100 kHz/div 100 kHz step @ 100 Hz/div 100 Hz step @ 100 Hz/div	1.4 s
EXMXR, FRQRNG if input transfer switch or preselector/ LPF switch is changed	350 ms
SPAN t0 phase lock span boundary (10 kHz/div to 1 MHz/div)	Add 150 ms per switch
IDENT ON @ 50 kHz @ 5 kHz @ 500 Hz	220 ms
REFLVL, RLMODE, MINATT, MAXPWR if RF attenuator is switched	32.5 ms 40.5 ms 156 ms
	Add 100 ms

Table 9-1 (cont)

Command	Time
CURVE	100 ms
CURVE?	60 ms
POINT (X argument only)	56 ms
FIBIG	760 ms
LFTNXT, RGTNXT	100 ms * (signal separation in div)
FMAX, FMIN	480 ms
SET? (command execution time)	0.5 s to 3 s
INIT	0.5 s to 3 s
CAL AUTO	35 s
DSTORE (display)	190 ms
DRECAL (display)	380 ms
STORE (settings)	80 ms
RECALL (settings)	500 ms
MFBIG	560 ms
MLFTNXT, MRGTNXT	400 ms * (signal separation in div)
TEST?	7.3 s
HRAMPL, LRAMPL	560 ms

Because of the way the spectrum analyzer handles output, it is free after it loads an output buffer. The additional time for the transfer is related to the listener for cases where the spectrum analyzer is faster. For instance, with 4041 controllers, the following transfer times have been observed.

Table 9-2
4041 TRANSFER TIMES

Command	Time
Display Data Output	
SET? response	624 ms
CURVE? response	
Binary (input as numbers)	3.4 s
ASCII (input as a string)	3.0 s
ASCII (input as numbers)	14.3 s
Display Data Input	
CURVE	
Binary (from number array)	1.1 s
ASCII (as a string)	8.1 s
ASCII (as numbers)	20.0 s



IEEE STD 488 (GPIB) SYSTEM CONCEPTS

The General Purpose Interface Bus (GPIB) is a digital control bus that allows efficient communications between self-contained instruments or devices interconnected in an instrumentation system. The GPIB is an interface system independent of the stimulus or measurement functions incorporated in any instrument.

Instruments or devices designed to operate on the digital control bus must be developed according to the specifications contained in IEEE Std 488-1978, "IEEE Standard Digital Interface for Programmable Instrumentation." At Tektronix, the IEEE 488 digital interface is commonly known as the General Purpose Interface Bus (GPIB). This section discusses the basic concepts of the GPIB. (For complete specifications, refer to the IEEE Std 488-1978 standard, published by the Institute of Electrical and Electronics Engineers, Inc.).

The GPIB has four elements; mechanical, electrical, functional, and operational. Of these four, only the last is device-dependent. Operational elements state the way in which each instrument reacts to a signal on the bus.

MECHANICAL ELEMENTS

The IEEE Std 488 defines the GPIB connector and cable assembly as the mechanical elements of the instrumentation system. Standardizing the connector and cable assembly ensures that GPIB-compatible instruments can be physically linked together with complete pin compatibility. The connector has 24 pins; sixteen active signal lines, seven interlaced grounds, and 1 shield connection. Standard connector pin arrangement and nomenclature for the digital control signals are illustrated in Figure A-1.

The cable that attaches to the GPIB connector must be no longer than 20 meters maximum with no more than fifteen peripheral devices (including a GPIB controller) connected at one time. The interconnecting cable assembly, which is an optional accessory to the 2755P, is provided with both a plug and receptacle connector type at each end of the cable to allow either a star or linear bus structure. Connectors may be rigidly stacked, using standard counter-bored captive screws.

ELECTRICAL ELEMENTS

The voltage and current values required at the connector nodes on the bus are based on TTL technology. The power source is not to exceed +5.25 V referenced

to logic ground. The standard defines the logic levels as follows.

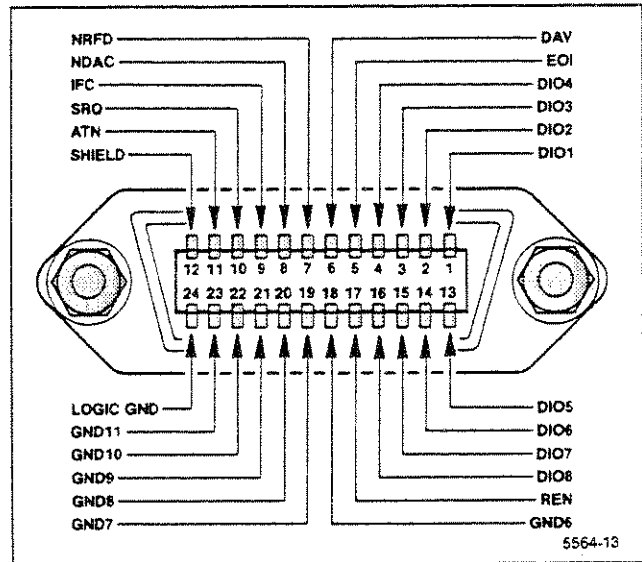

Figure A-1. IEEE Std 488 (GPIB) connector.

1. Logical 1 is a true state, low voltage level ($\leq +0.8$ V), signal line is asserted.

2. Logical 0 is a false state, high voltage level ($\geq +2.0$ V), signal line is not asserted.

Messages can be sent over the GPIB as either active-true or passive-true signals. Passive-true signals occur at a high voltage level and must be carried on a signal line using open-collector devices. Active-true signals occur at a low voltage level.

FUNCTIONAL ELEMENTS

The functional elements of the GPIB cover three areas.

1. The ten major interface functions of the GPIB, are listed in Table A-1. Each interface function is a system element that provides the basic operational facility through which an instrument can receive, process, and send messages over the GPIB.

2. The second functional element is the specific protocol by which the interface functions send and receive their limited set of messages.

3. The logical and timing relationships between allowable states for all interface functions is the third area covered.

Table A-1

MAJOR GPIB INTERFACE FUNCTIONS

Interface Function	Symbol
Source Handshake	SH
Acceptor Handshake	AH
Talker or Extended Talker	T or TE
Listener or Extended Listener	L or LE
Service Request	SR
Remote-Local	RL
Parallel Poll	PP
Device Clear	DC
Device Trigger	DT
Controller	C

NOTE

The IEEE Std 488 standard defines the ten interface functions, the specific protocol, and timing relationships by the use of state diagrams. Not every instrument on the bus will have all ten interface functions incorporated, because only those functions important to a particular instrument's purpose need be implemented.

A TYPICAL GPIB SYSTEM

A typical GPIB instrumentation system is illustrated in Figure A-2, and it includes the nomenclature for the sixteen active signal lines. Only four instruments are shown connected directly to the control bus, but the GPIB can support up to fifteen instruments connected directly to the bus. However, more than fifteen devices can be interfaced to a single bus if they do not connect directly to the bus, but are interfaced through a primary device. Such a scheme can be used for programmable plug-ins housed in a mainframe where the mainframe is addressed with a primary address code and the plug-ins are addressed with a secondary address code.

To maintain the electrical characteristics of the bus, a device load should be connected for each two meters of cable length. Although instruments are usually spaced no more than two meters apart, they can be separated farther apart if the required number of device loads are lumped at any given point. For proper operation, at least

two-thirds of the instruments connected directly to the bus must be in the power-on state.

TALKERS, LISTENERS, AND CONTROLLERS

A talker is an instrument that can send messages and data over the bus; a listener is an instrument that can accept messages and data from the bus. An instrument can be a talker only, listener only, or be both a talker and a listener. Unless a device is in the talk-only or listen-only mode, it can only communicate with other devices on the bus when it is enabled to do so by the controller in charge of the instrumentation system.

A controller is an instrument that determines, by software routines, which instrument will talk and which instruments will listen during any given time interval. The controller has the ability to assign itself as a talker or a listener whenever the program routine requires it. In addition to designating the current talker and listeners for a particular communication sequence, the controller is assigned the task of sending special codes and commands (called interface control messages) to any or all instruments on the bus. A complete operating system may contain more than one controller. The IEEE standard has provisions for a system controller that operates with another controller in charge of the bus. The controller that is in charge of the bus can take control only when it is directed to do so by the system controller. The system controller itself may be, but is not necessarily, the controller in charge of the bus.

INTERFACE CONTROL MESSAGES

The two types of interface control messages are multi-line messages sent over the data bus and uni-line messages.

A message that shares a group of signal lines with other messages, in some mutually exclusive set, is called a multi-line message (only one multi-line message (message byte) can be sent at one time).

A message sent over a single line is called a uni-line message (two or more of these messages can be sent concurrently.)

Only multi-line messages are discussed here; uni-line messages are discussed later under GPIB Signal Line Definitions.

The interface control messages (refer to Figure A-3) are sent and received over the data bus only with the ATN (attention) line asserted (true). Interface message coding can be related to the ISO (International Standards Organization) 7-bit code by relating data bus lines DIO1 through DIO7 to bits B1 through B7, respectively, in the Bits column of Figure A-3.

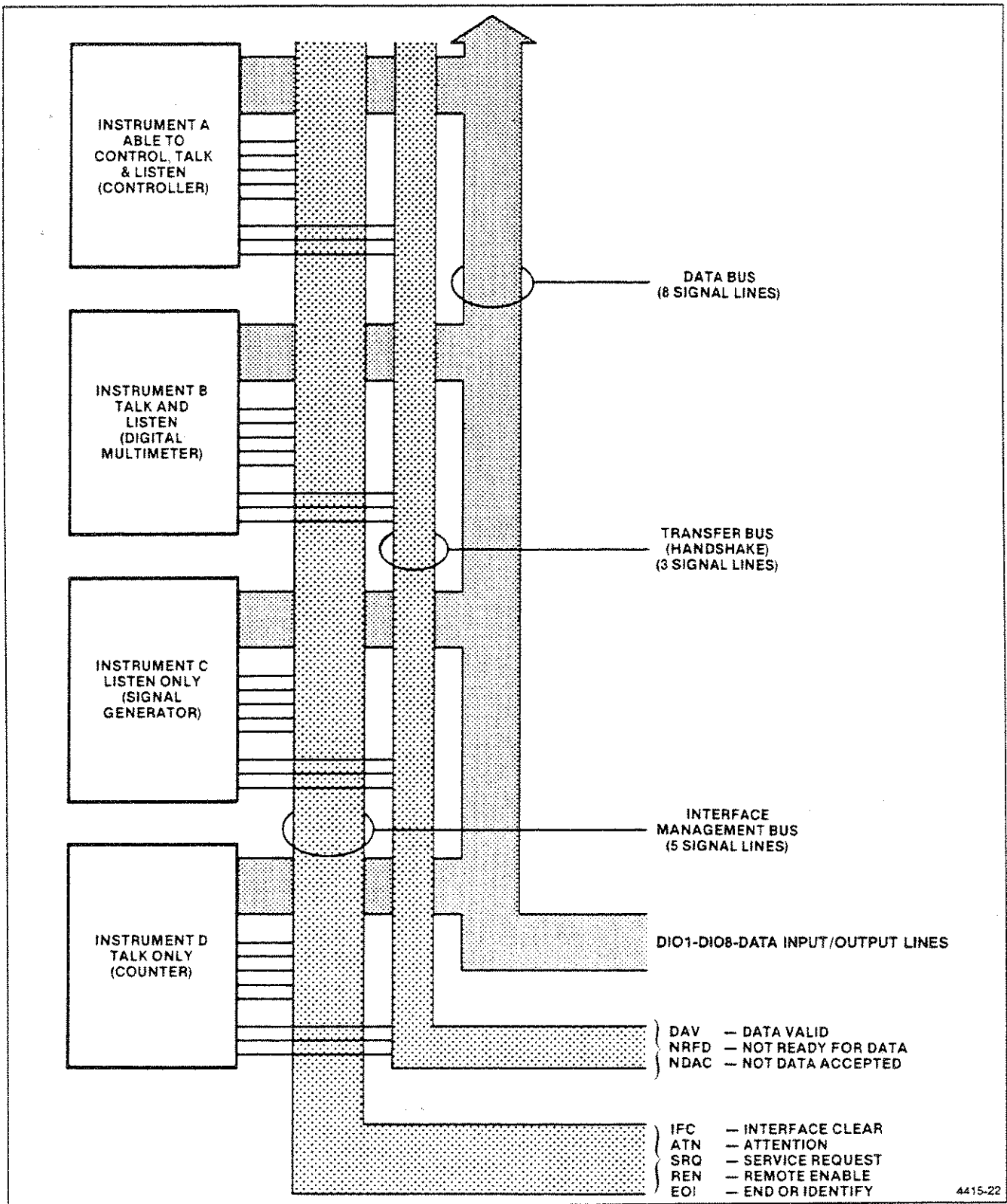

Figure A-2. A typical GPIB system.

Interface control messages (refer to Table A-2) include the primary talk and listen addresses for instruments on the bus, addressed commands (only instruments previously addressed to listen will respond to these commands), universal commands (all instruments, whether they have been addressed or not, will respond to these commands), and secondary addresses for devices interfaced through a primary instrument. Parallel Poll Enable (PPE) messages are derived from the characters in the first column under Lower Case letters in Figure A-3 (decimal coded characters 96 through 111). The standard recommends the use of decimal code 112 (lower case letter p) for the Parallel Poll Disable (PPD) command. All parallel poll configured instruments respond with status information at the same time when the EOI line is asserted with ATN true.

Table A-2
INTERFACE MESSAGES (REFERRED TO IN THIS APPENDIX) AND FUNCTIONS

Mnemonic	Message	Interface Function
Remote Messages Received		
	Attention	AH,C,L, LE,PP, SH,T,TE
DAC	Data Accepted	SH
DAV	Data Valid	AH
DCL ^a	Device Clear	DC
GET ^a	Group Execute Trigger	DT
GTL ^a	Go To Local	RL
IFC	Interface Clear	C,L,LE, T,TE
LLO ^a	Local Lockout	RL
MSA ^a	My Secondary Address	LE,TE
MTA ^a	My Talk Address	T,TE
PPC ^a	Parallel Poll Configure	PP
PPD ^a	Parallel Poll Disable	PP
PPE ^a	Parallel Poll Enable	PP
PPU ^a	Parallel Poll Unconfigure	PP
REN	Remote Enable	RL
RFD	Ready For Data	SH
SDC ^a	Selected Device Clear	DC
SPD ^a	Serial Poll Disable	T,TE
SPE ^a	Serial Poll Enable	T,TE
SRQ	Service Request	(via C)
TCT ^a	Take Control	C
UNL ^a	Unlisten	L,LE
ATN	Attention	C
DAC	Data Accepted	AH
DAV	Data Valid	SH
DCL ^a	Device Clear	(via C)
GET ^a	Group Execute Trigger	(via C)
GTL ^a	Go To Local	(via C)
IFC	Interface Clear	C

^a Multi-line messages.

Table A-2 (cont)

INTERFACE MESSAGES (REFERRED TO IN THIS APPENDIX) AND FUNCTIONS

Mnemonic	Message	Interface Function
Remote Messages Sent		
LLO ^a	Local Lockout	(via C)
MSA ^a	My Secondary Address	(via C)
MTA ^a	My Talk Address	(via C)
PPC ^a	Parallel Poll Configure	(via C)
PPD ^a	Parallel Poll Disable	(via C)
PPE ^a	Parallel Poll Enable	(via C)
PPU ^a	Parallel Poll Unconfigure	(via C)
REN	Remote Enable	C
RFD	Ready For Data	AH
SDC ^a	Selected Device Clear	(via C)
SPD ^a	Serial Poll Disable	(via C)
SPE ^a	Serial Poll Enable	(via C)
SRQ	Service Request	SR
TCT ^a	Take Control	(via C)
UNL ^a	Unlisten	(via C)
UNT ^a	Untalk	(via C)

DEVICE-DEPENDENT MESSAGES

The IEEE standard does not specify the coding of device-dependent messages (messages that control the internal operating functions of a device). After addressing a talker and the required number of listeners via interface control messages, the controller unasserts the ATN line (false) on the bus. When ATN becomes false (high), any commonly understood 8-bit binary code may be used to represent a device-dependent message.

However, the standard recommends that the alphanumeric codes associated with the numbers, symbols, and upper case characters (decimal 32 to decimal 94) in the ASCII Code Chart (Figure A-3) be used to compose device-dependent messages. One example of a device-dependent message could be the following ASCII character string:

MODE V;VOLTS 2.5E-3;FREQ 1.0E3

The ASCII character string, sent with the ATN line unasserted, tells the instrument to set its front panel controls to the voltage mode and output a 2.5 mV signal at a frequency of 1000 Hz.

When 8-bit binary codes other than the ISO 7-bit are used for device-dependent messages, the most significant bit should be on data line D108 (for bit-8).

^a Multi-line messages.

To summarize the difference between interface control messages and device-dependent messages on the data bus, remember that any message sent or received when the ATN line is asserted (low) is an interface control message. Any message (data bytes) sent or received when the ATN line is unasserted (high) is a device-dependent message.

GPIB SIGNAL LINE DEFINITIONS

Figure A-2 shows how the sixteen active signal lines on the GPIB are functionally divided into three component buses: an eight-line data bus, a three-line data byte transfer control (handshake) bus, and a five-line general interface management bus.

The data bus contains eight bi-directional signal lines, DI01 through DI08. Information, in the form of data bytes, is transferred over this bus. A handshake timing sequence between the enabled talker and the enabled listeners on the three-line data transfer control bus transfers one data byte (eight bits) at a time. These data bytes are sent and received in a byte-serial, bit-parallel fashion.

Since the handshake sequence is an asynchronous operation (no clock signal on the bus), the data transfer rate is only as fast as the slowest instrument involved in a data byte transfer. A talker cannot place data bytes on the bus faster than the slowest listener can accept them.

Figure A-4 illustrates the flow of data bytes on the bus when a typical controller sends ASCII data to an assigned listener. The first data byte (decimal 44) enables an instrument at address 12 as a primary listener. The second data byte (decimal 108) is optional; for example, enabling a plug-in device at secondary address 12 as the final destination of the data to follow. The data is the two ASCII characters A and B (decimal 65 and decimal 66). Note that the ATN line is asserted for the first two data bytes and unasserted for the device-dependent character to indicate the last data byte in the message.

The controller activates the ATN line again and sends the universal unlisten (UNL) and untalk (UNT) commands to clear the bus. Six handshake cycles on the data transfer control bus are required to send the six data bytes.

Transfer Bus (Handshake)

Each time a data byte is transferred over the data bus, an enabled talker and all enabled listeners execute a handshake sequence via signal lines DAV, NRFD, and NDAC (see Figure A-5 — the ATN line is shown to illustrate the controller's role in the process).

DAV (Data Valid). The DAV signal line is asserted by the talker after the talker places a data byte on the data bus. When asserted (low), DAV tells each assigned listener that a new data byte is on the bus. The talker is inhibited from asserting DAV as long as any listener holds the NRFD signal line asserted.

NRFD (Not Ready For Data). An asserted NRFD signal line indicates one or more of the assigned listeners are not ready to receive the next data byte from the talker. When all of the assigned listeners for a particular data byte transfer have released NRFD, the NRFD line becomes unasserted (high). When NRFD goes high, the RFD message (Ready For Data) tells the talker it may place the next data byte on the data bus.

NDAC (Not Data Accepted). Each assigned listener holds the NDAC signal line asserted until the listener accepts the data byte currently on the bus. When all assigned listeners have accepted the current data byte, the NDAC signal line becomes unasserted (high), telling the talker to remove the data byte from the bus. The DAC message (Data Accepted) tells the talker that all assigned listeners have accepted the current data byte.

NOTE

One handshake cycle transfers one data byte; then, the listeners reset the NRFD line high and the NDAC line low before the talker asserts DAV for the next data byte transfer. Both NRFD and NDAC high at the same time is an invalid state on the bus.

Management Bus

The management bus is a group of five signal lines that are used to control the operation of the IEEE Std 488 (GPIB) Digital Interface.

IFC (Interface Clear). The system controller is the only instrument on the bus allowed to assert IFC. IFC is asserted for greater-than 100 μ s to place all instruments in a predetermined state. While IFC is being sent, only the DCL (Device Clear), LLO (Local Lockout), PPU (Parallel Poll Unconfigure), and REN (Remote Enable) interface messages (universal commands) will be recognized.

ATN (Attention). The controller in charge is the only instrument on the bus allowed to assert ATN. ATN is asserted when an instrument connected to the bus is being enabled as a talker or listener, or when sending other interface control messages. As long as the ATN line is asserted (low), only instrument address codes and interface control messages are sent over the bus. When the ATN line is unasserted, only those instruments enabled as a talker and listener(s) can send and receive data over the bus.

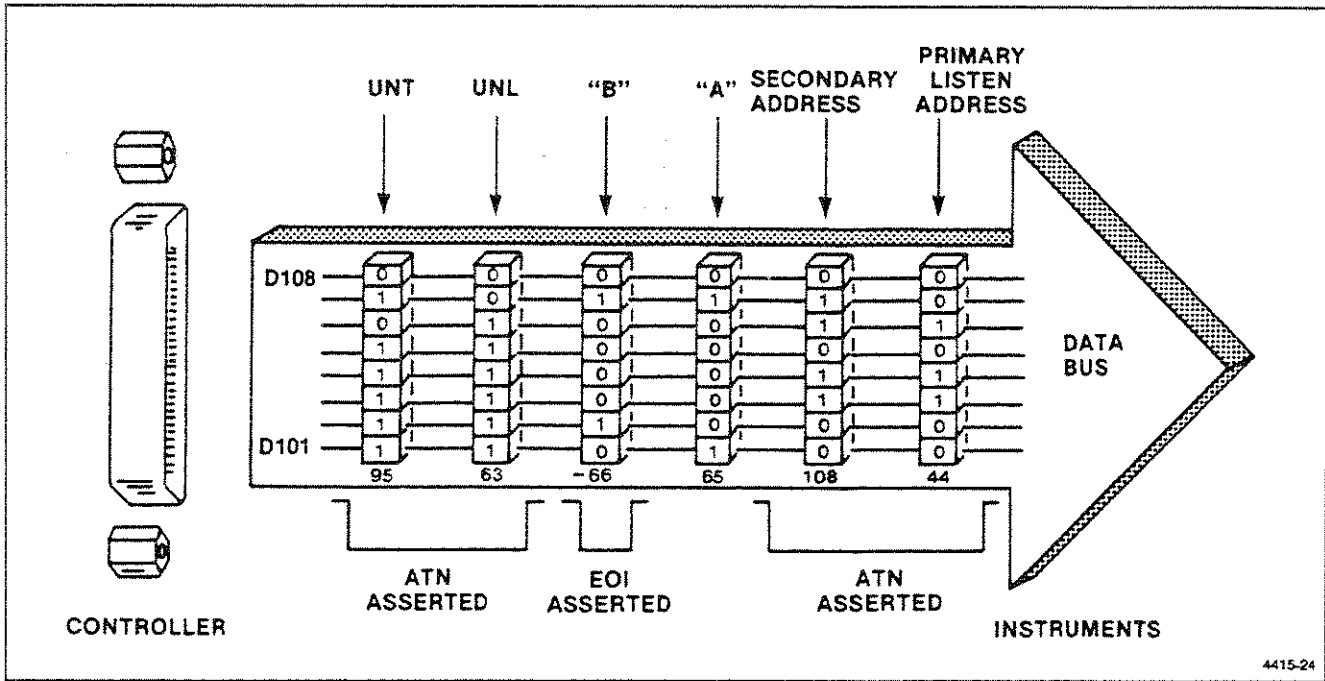

Figure A-4. An example of data byte traffic on the GPIB.

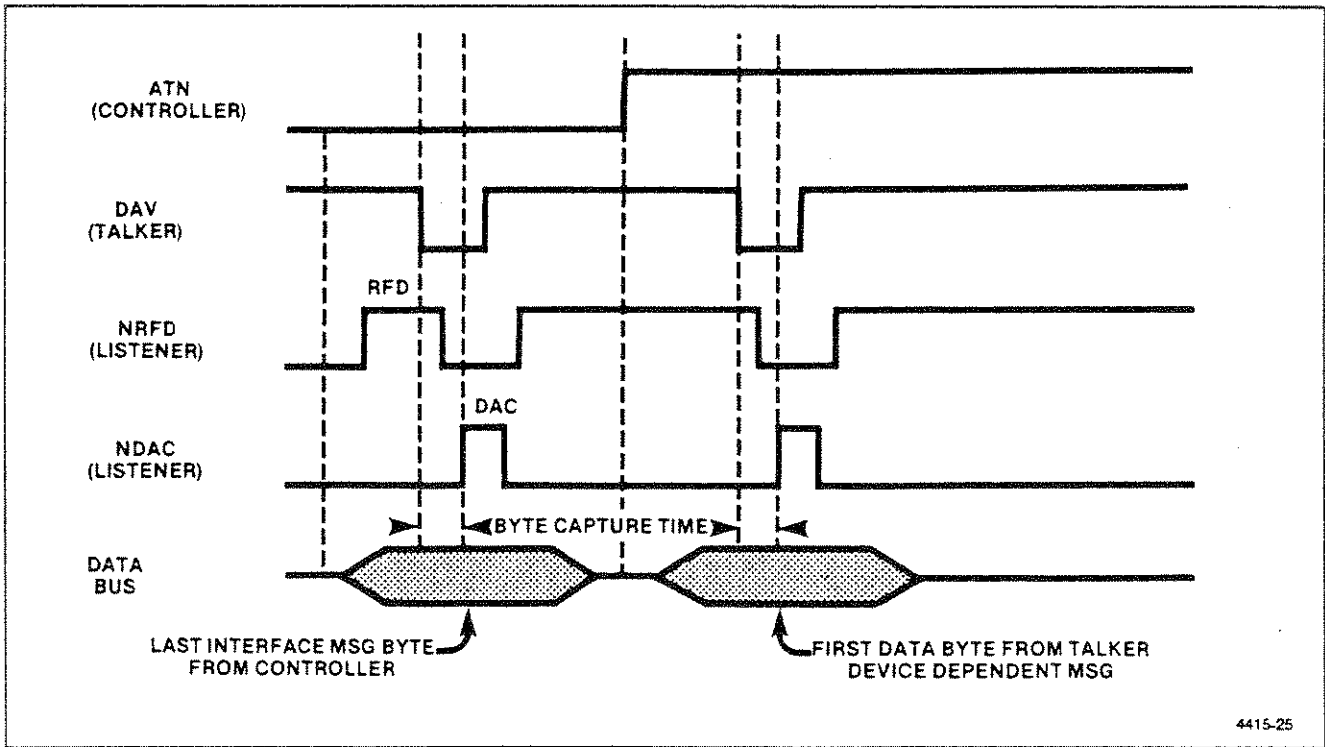

Figure A-5. A typical handshake timing sequence (idealized). Byte capture time is dependent on the slowest instrument involved in the handshake. RFD means Ready For DATA; DAC means Data Accepted.

SRQ (Service Request). Any instrument connected to the bus can request the controller's attention by asserting the SRQ line. The controller responds by asserting ATN and executing a serial poll routine to determine which instrument is requesting service. The instrument requesting service responds with a device-dependent status byte with bit seven asserted. When the instrument requesting service is found, program control is transferred to a service routine for that instrument. When the service routine is completed, program control returns to the main program. (The controller does not have to see the SRQ line asserted to perform a polling routine; it may do so whenever a program requires it).

REN (Remote Enable). The system controller asserts the REN signal line whenever the interface system operates under remote program control. Used with other interface control messages, such as LLO (Local Lockout) or GTL (Go To Local), the REN signal causes an instrument on the bus to select between two alternate sources of programming data. A remote-local interface function indicates to an instrument that the instrument will use either information input from the interface (remote) or to information input by the operator via the front panel controls (local).

EOI (End Or Identify). A talker can use the EOI signal line to indicate the end of a data transfer sequence. The talker asserts EOI as the last byte of data is transmitted. In this case, the EOI line is essentially a ninth data bit and must observe the same settling time as the data on the data bus. When an instrument controller is listening, it assumes that a data byte sent with EOI asserted is the last data byte in the complete message. When the instrument controller is talking, it may assert the EOI signal line as the last data byte is transferred. The EOI line is also asserted with the ATN line true if the controller conducts a parallel polling sequence on the bus. The EOI line is not used for a serial polling sequence.

INTERFACE FUNCTIONS AND MESSAGES

The ten major interface functions listed in Table A-1 provide a variety of capabilities and options for an instrumentation system. These functions may be implemented in, or for, any particular instrument with instrument hardware or with a programming routine (software).

Only those functions necessary for an instrument's purpose need be implemented by the instrument's designer; it is not likely that one single instrument will have all ten interface functions. For example, an instrument generally doesn't need to implement the Parallel Poll (PP) function if the instrument can respond to a serial polling sequence from the controller in charge of the GPIB system.

The following discusses the interface functions and their relationship to the interface control messages shown in Figure A-3. All the interface control messages discussed are sent and received over the GPIB with the ATN line asserted (low).

RL (Remote-Local Function)

The RL function provides an instrument with the capability to select between two sources of input information. This function indicates to the instrument that its internal device-dependent functions are to respond to information input from the front panel (Local) or to corresponding programming information from the GPIB (Remote). Only the system controller is permitted to assert the REN (Remote Enable) line, whether or not it is the controller in charge at the time.

When the system controller asserts the REN line, an instrument on the GPIB goes to a remote mode when it is addressed as a listener with its listen address, not before. An instrument remains in a remote mode until the REN line is released (high), or an optional front-panel switch on the instrument is activated to request the local mode, or a GTL (Go To Local) command is received while the instrument is enabled as a listener.

However, the controller can disable the instrument's front-panel "return to local" switch(es) by sending a LLO (Local Lockout) command. The LLO command must be preceded or followed by a listen address (MLA) to cause the instrument to go to a remote mode with front-panel lockout. The UNL (Unlisten) command does not return an instrument to the local mode.

When the REN line goes false, it must be recognized by all instruments on the bus and they must go to the local mode within 100 micros. If data bytes are still being placed on the bus when REN goes false, the system program should assure that the data bytes are sent and received with the knowledge that the system is in a local mode, not remote.

T/TE and L/LE (Talker and Listener Functions)

NOTE

Although discussed under one heading, the T/TE and L/LE functions are independent of each other.

The T (Talker) and TE (Talker Extended) functions provide an instrument and its secondary devices, if any, with the capability to send device-dependent data over the GPIB (or, in case of a controller, the capability to send device-dependent program data) over the GPIB.

The Talker (T) function is a normal function for a talker and uses only a one-byte primary address code called MTA (My Talk Address). The Talker Extended (TE) function requires a two-byte address code; an MTA code followed by the second byte called MSA (My Secondary Address).

Only one instrument in the GPIB system can be in the active talker state at any given time. A non-controller commences talking when ATN is released and continues its talker status until an Interface Clear (IFC) message occurs or an Untalk (UNT) command is received from the controller in charge. The instrument will stop talking and listen any time that the controller in charge asserts ATN.

One or more instruments on the bus can be programmed for the L (Listener) function by use of their specific primary listen address (called MLA). Some of the instruments interfaced to the bus may be programmed for the LE (Listener Extended) function, if implemented. The LE function requires a two-byte address code. No L or LE function is active during the time that ATN is asserted.

All talker and listener functions must respond to ATN within 200 ns. They must also respond to IFC in less than 100 micros.

An instrument may be a talker only, a listener only, or implement all functions. In any case, its address code has the form X10TTTTT for a talker and X01LLLLL for a listener. For instruments with both T and L functions, the T-bit binary values are usually equal to the binary value of the L bits. Before applying power to the system, the system operator sets these five least significant bits by means of an address switch on each instrument. The controller's address code may be implemented in software.

The system program, run from the controller, designates the primary talker and primary listener status of the desired instruments by coding data bits 6 and 7; 1, 0, respectively, for a talker and 0, 1, respectively, for a listener. Secondary talk and listen addresses (or commands) are represented by the controller sending both data bits (6 and 7) as a logical 1. The controller may listen to bus traffic without actually addressing itself over the bus.

SH and AH (Source and Acceptor Handshake Functions)

NOTE

Although discussed under one heading, the SH and AH functions are independent of each other.

The SH (Source Handshake) function guarantees proper transmission of data, while the AH (Acceptor Handshake) function guarantees proper reception of data. The interlocked handshake sequence between these two functions guarantees asynchronous transfer of each data byte. The handshake sequence is performed via the NRFD, DAV, and NDAC signal lines on the bus (see Figure A-5). Both functions must respond to ATN within 200 n.

The SH function must wait for the RFD (Ready For Data) message plus wait at least 2 micros before asserting DAV; this allows the data to settle on the data bus. If three-state drivers are used, the settling time is reduced to RFD plus 1.1 micros. Faster settling times are allowed under special conditions and warning notes in the standard. The time it takes for the AH function to accept an interface message byte is dependent on how the designer implemented the function.

DC (Device Clear Function)

The DCL (Device Clear) function allows the controller in charge to "clear" any or all instruments on the bus. The controller (under program direction) asserts ATN and sends either the universal DCL (Device Clear) command or the SDC (Selected Device Clear) command.

When the DCL message is received, all instruments on the bus must clear or initialize their internal device functions. When the controller sends the SDC command, only those instruments that have been previously addressed to listen must respond. The IEEE 488 standard does not specify the settings an instrument must go to as a result of receiving the DCL or SDC command. (In general, these commands are used only to clear the GPIB interface circuits within an instrument.)

DT (Device Trigger Function)

The DT (Device Trigger) function allows the controller in charge to start the basic operation specified for an instrument or group of instruments on the bus. The IEEE 488 standard does not specify the basic operation an instrument is to perform when it receives the GET (Group Execute Trigger) command. To issue the GET command, the controller asserts ATN, sends the listen addresses of the instruments that are to respond to the trigger, and then sends the GET message.

Once an instrument starts its basic operation in response to GET, the instrument must not respond to subsequent trigger-state transitions until the current operation is complete. Only after completing the operation can the instrument repeat its basic operation in response to the next GET message. Thus, the basic operating time is the major factor that determines how fast the instrument(s) can be repeatedly "triggered" by commands from the bus.

C, SR, and PP (Controller, Service Request, and Parallel Poll Functions)

The C (Controller) function provides the capability to send primary talk and listen addresses, secondary addresses, universal commands, and addressed commands to all instruments on the bus. The Controller function also provides the capability to respond to a service request message (SRQ) from an instrument or to conduct a parallel poll routine to determine the status of any or all instruments on the bus that have the Parallel Poll (PP) function implemented.

If an instrumentation system has more than one controller, only the system controller is allowed to assert the IFC (Interface Clear) and REN (Remote Enable) lines at any time during system operation, whether or not it is the controller in charge at the time.

If a controller requests system control from another controller and it receives a message from another controller to send REN, the system controller must verify that the REN line remains unasserted (false) for at least 100 micros before asserting REN. The time interval that REN is asserted depends on the remote programming sequence and will vary with the program. The IFC line must be asserted for at least 100 micros.

The Controller function has specified time intervals for certain operations. For example, the execution time for parallel polling instruments on the bus cannot be less than 2 micros. If the controller is in the controller active wait state and does not receive an internal message to conduct a parallel poll, it must wait for at least 1.5 micros before going to the controller active state in order to give the NRFD, NDAC, and EOI lines sufficient time to assume their valid states.

The controller must also have a delay of at least 2 micros (1.1 micros for tri-state drivers) in order for the instruments to see the ATN line asserted before the controller places the first data byte on the bus.

Taking Control (Asynchronous or Synchronous)

All data bytes transmitted over the GPIB with the ATN line asserted are interpreted as system control information. Asserting ATN directly at any moment is an asynchronous operation with respect to the bus and may cause loss of data if a handshake cycle is in progress. To prevent loss of data, a controller can take control synchronously, that is, it can monitor the Transfer Bus and only assert ATN when DAV is unasserted (false).

Passing Control

As a controller in charge, the system controller (program) may relinquish control to any other instrument in the system capable of acting as a controller. The controller in charge first addresses the other controller as a

talker and then sends the TCT (Take Control) command. The other controller then becomes the controller in charge when ATN is released.

Performing a Serial Poll

The controller-in-charge may conduct a serial poll at any time, whether or not an instrument on the bus has asserted the SRQ line. (Most, but not all, instruments have the Service Request (SR) function.)

To perform a serial poll, the controller first asserts ATN and issues the Untalk (UNT) and Unlisten (UNL) commands. The controller then sends the Serial Poll Enable (SPE) command, followed by the talk address of the first instrument to be polled. The controller then releases ATN and the addressed talker responds by sending its status byte over the bus. If the addressed talker has requested service, it must assert bit seven of the status byte and encode the remaining seven bits to indicate the reason for asserting SRQ. Status bytes are device-dependent and are not specified in the IEEE 488 standard. An addressed instrument will release its SRQ line when serial polled, but other instruments may still hold it asserted. When the controller has read the status byte of an addressed instrument, it reasserts ATN and addresses the next instrument to talk, then releases ATN and receives the instrument's status byte. The routine continues until the controller no longer detects the SRQ line asserted. At this time, the controller should send the Serial Poll Disable (SPD) message and, optionally, send the UNT message to release the last active talker.

The Parallel Poll (PP) function provides an instrument with the capability to present one, and only one, bit of status information to the controller without being previously addressed to talk. The parallel polling capability requires a commitment by the system program to periodically conduct a parallel poll sequence.

When an instrument responds to a parallel poll, the single data bit presented to the controller may or may not indicate a need for service. If the data bit is used as a service request indication, the controller should perform a serial poll in order to obtain a complete status byte with more information (if the device has the SR function implemented).

Before an instrument can respond to a parallel poll, the GPIB system must first be configured. In a typical sequence, the controller first sends an UNL command to clear the bus of listeners, then the listen address of the device to be configured. Following this, the controller sends the PPC (Parallel Poll Configure) command followed by a PPE (Parallel Poll Enable) message. The PPE message contains coded information that tells the selected instrument which data line will carry the PP status bit for that device. This entire sequence is repeated for each instrument to be configured.

The PPE message(s) sent by the controller has the form X110SPPP. Bit 4 (S) is called the sense bit and the three least significant bits (PPP) represent an octal number (0 through 7) that corresponds to a specific line on the data bus that an instrument must assert if its internal status has the same value as the sense bit (S may equal 1 or 0).

The actual parallel poll takes place after each instrument has been completely configured. The concept is to have the controller receive one data byte that contains status information on all of the addressed instruments. To receive this status byte, the controller asserts the EOI line and the ATN line. The assertion of EOI may be coincident with ATN or later, so long as both are asserted. This may occur any time after the last PPE message. The controller then reads the data bus lines while ATN and EOI are asserted to interpret the status of all selected instruments.

To conclude the parallel poll, the controller releases EOI and then ATN. The instrument(s) do not need to be reconfigured for each subsequent parallel poll. The PPU (Parallel Poll Unconfigure) command will clear all device configurations and prevent them from responding to future polls. The PPD (Parallel Poll Disable) command accomplishes essentially the same thing, except that the PP function remains in the "configured" state. PPU is a universal command (all instruments) while PPD is used with PPC and becomes an addressed command (only those devices selected with PPC will accept PPD.)



EVENT?/ERR? RESPONSES

Event Code	Error Code	Meaning
Command Errors		
0	0	No error
101		Command header error
103	1	Command argument error
106		Missing argument
108		Checksum error
109	4	Bytecount error
103	6	Illegal placement of question mark
101	7	Query not recognized
101	8	Header not recognized
106	9	End of message unit not expected; arguments missing
103	10	Character argument not allowed for this header
103	11	Numeric argument not allowed for this header
103	12	String argument not allowed for this header
103	13	Binary argument not allowed for this header
103	14	Link not allowed for this argument
103	20	Special argument type not recognized
103	21	Special argument not allowed for this header
103	22	Character argument not recognized
150	24	Input buffer overflow

EVENT?/ERR? RESPONSES (cont)

Event Code	Error Code	Meaning
Execution Errors		
250	26	Output buffer overflow; remaining output lost
201	27	Attempt to execute command in Local mode
205	28	FREQ, TUNE, FIRST, or SECOND out of range
205	29	FRQRNG out of range
205	31	SPAN out of range
205	32	RESBW out of range
205	33	MAXPWR or MINATT out of range
205	34	REFLVL out of range
205	35	VRTDSP LIN out of range
205	36	VRTDSP LOG out of range
205	37	TIME out of range
204	39	IDENTify not allowed in this span/div
204	40	Signal finds not allowed in this span/div
204	41	Invalid DATA or ADDR argument contents
204	42	DATA direction not compatible with ADDR direction
206	45	GET (Group Execute Trigger) ignored (not executed)
205	46	NUMEV out of range
205	47	STORE, RECALL, DSTORE, or DRECAL out of range
203	100	<SHIFT> SRQ pushbutton was pushed
204	101	Function not available when SGTRAK is on
205	102	Frequency range limited in 75 Ω input — Option 07 only
205	103	Frequency out of range after step
204	104	Bandwidth mode is not available when in linear
205	105	Illegal sweep range
Execution Warnings		
551	50	SPAN defaulted to MAX
553	52	UNCAL light turned on
555	53	Multiple use of display buffer
554	54	UNCAL light turned off
560	110	STEP size out of range — set to maximum
561	111	SPAN defaulted to minimum span
Internal Warnings		
650	55	Frequency reference changed to INT
651	56	Frequency reference changed to EXT

COMMAND AND QUERY DESCRIPTIONS

EVENT?/ERR? RESPONSES (cont)

Event Code	Error Code	Meaning
Internal Errors		
350	57	Tuning DAC carry operation failed
351	58	Failed to lock 1st LO
352	59	Lost 1st LO lock
353	60	Recentering failure on unlocking of 1st LO
354	61	Calibration failure
355	62	Battery-operated RAM checksum error
382	72	1st LO tuning system failed
386	74	2nd LO tuning system failed
388	75	Phase lock system failed
396	79	Power supply out of regulation
398	80	Frequency reference unlocked
383	82	1st LO tuning system recovered from a failure
387	84	2nd LO tuning system recovered from a failure
389	85	Phase lock system recovered from a failure
397	89	Power supply regained regulation
399	90	Frequency reference relocked
302	99	Unrecognized event occurred
System Events		
401	97	Power just came on
402	98	Operation complete (end of sweep)
403	100	<SHIFT> SRQ pushbutton was pushed
Marker Execution Errors		
205	120	Frequency out of range because marker is on inactive trace
204	121	Function not available when marker is on an inactive trace
204	122	Function not available when marker is off
204	123	Function not available when delta marker is off
204	124	Function not available in BWMODE
204	125	Function not available when marker is on a B-SAVEA trace
204	126	Function not available when in dB/Hz
Marker Execution Warning		
558	130	MLFTNX, MRGTNX, MFBIG, HRAMPL, LRAMPL, PKFIND, MVRTDB, or MVLTDDB commands could not find signal

Message Unit	Page
ALLEV? (all events)	8-11
ARES (auto resolution bandwidth)	4-13
AVIEW (A waveform display)	4-27
BMINA (B-A waveform display)	4-29
BVIEW (B waveform display)	4-28
BWMODE (marker bandwidth mode)	5-8
BWNUM (marker bandwidth number)	5-8
CAL (cal)	4-18
CENSIG (center signal)	7-3
CLIP (clip baseline)	4-33
CRSOR (peak/average cursor)	4-30
CURVE (display curve)	6-3
DCOPY? (copy display)	6-5
DEGAUS (degauss tuning coils)	4-8
DELFR (delta-frequency)	4-8
DISCOR (disable tuning corrections)	4-5
DPMK (display pointer to marker)	5-4
DPRE? (display preamble)	6-4
DRECAL (recall display)	4-29
DSTORE (store display)	4-29
DT (define triggered events)	8-11
ENCAL (enable calibration factors)	4-19
EOS (end of sweep)	8-8
EVENT? (event information)	8-11
EVQTY? (event quantity)	8-12
FIBIG (find biggest signal)	7-2
FINE (fine reference level steps)	4-20
FIRST (1st LO frequency)	4-5
FMAX (find maximum value)	7-2
FMIN (find minimum value)	7-2
FREQ (center frequency)	4-3
FRQRNG (frequency range)	4-6
GRAT (graticule illumination)	4-33
HDR (header)	8-7
HRAMPL (next higher amplitude)	5-7
ID? (identify instrument)	8-6
IMPED (impedance — Option 07 only)	4-8
IDENT (identify)	4-13
INIT (initialize settings)	8-6
LFTNXT (find left-next signal)	7-2
LORDO? (lower readout)	6-7
LRAMPL (next lower amplitude)	5-8
MAMPL? (marker amplitude)	5-4
MARKER (marker mode)	5-1
MAXPWR (maximum input power)	4-22
MCEN (marker to center)	5-5
MCPOIN (marker coupled to the display pointer)	5-5
MDRDO? (middle readout)	6-6
MEXCHG (marker exchange)	5-5
MFBIG (marker peak find)	5-9
MFREQ (marker frequency)	5-5
MINATT (minimum RF attenuation)	4-21
MKDP (marker to display pointer)	5-6
MLFTNX (marker left next)	5-9
MLOCAT? (marker location)	5-6
MMAX (move marker to maximum)	5-10

2754P COMMANDS AND QUERIES (cont)

Message Unit	Page	Message Unit	Page
MMIN (move marker to minimum)	5-11	WAIT (wait for end of sweep)	8-7
MRGTNX (marker right next)	5-11	WARMSG	8-9
MSTEP (minus step)	4-7	WAVFRM? (waveform)	6-4
MTOP (marker to reference level)	5-7	WFMPRE (waveform preamble)	6-1
MTRACE (marker trace position)	5-2	ZEROSP (zero span)	4-11
MTUNE (tune marker)	5-7	ZOOM (zoom)	5-18
MVLFDB (move marker left x dB)	5-12		
MVRTDB (move marker right x dB)	5-13		
MXHLD (maximum hold)	4-30		
MXSPN (max-span mode)	4-12		
NSELVL (noise level normalization)	5-3		
NUMEV (number of events)	8-11		
PEAK (peaking)	4-21		
PKFIND (marker to maximum above threshold)	5-10		
PLOT? (plot display)	4-35		
PLSTR (pulse stretcher)	4-23		
POFSET (set K)	4-36		
POINT (display data point)	7-1		
PSTEP (plus step)	4-7		
PTYPE (plotter type)	4-36		
RDOUT (readout message)	6-5		
RECALL (recall settings)	4-35		
REDOUT (display readout)	4-32		
REFLVL (reference level)	4-16		
REPEAT (repeat execution)	8-7		
RESBW (resolution bandwidth)	4-12		
RFATT? (RF attenuation)	4-22		
RGTNXT (find right-next signal)	7-2		
RLMODE (reference level mode)	4-20		
RLUNIT (reference level unit)	4-17		
RQS (request service)	8-8		
SAVEA (save A waveform)	4-28		
SECOND (2nd LO frequency)	4-5		
SET? (instrument settings)	8-1		
SGERR (signal find error)	5-17		
SGTRAK (signal track)	5-3		
SIGSWP (single sweep)	4-25		
SPAN (frequency span/div)	4-10		
STATUS BYTE (response to serial poll)	8-9		
STEP (step size)	4-6		
STORE (store settings)	4-35		
STSTOP (start-stop frequency)	4-7		
STYPE (signal type)	5-13		
TEST? (internal test)	8-12		
TEXT (text)	6-6		
THRHLD (marker threshold)	5-12		
TIME (time/div)	4-26		
TMODE (set tune mode)	4-4		
TOPSIG (move signal to top)	7-3		
TRIG (triggering mode)	4-24		
TUNE (increment frequency)	4-4		
UPRDO? (upper readout)	6-6		
VIDFLT (video filters)	4-23		
VRTDSP (vertical display)	4-16		

STATUS BYTE

8	7	6	5	4	3	2	1	Decimal	Condition
0	1	0	X	0	0	0	1	65,81	Power on
0	X	0	X	0	0	1	0	2,18,66,82	End of Sweep
0	0	0	X	0	0	0	0	0,16	Ordinary operation
0	X	1	X	0	0	0	1	33,49,97,113	Command error
0	X	1	X	0	0	1	0	34,50,98,114	Execution error
0	X	1	X	0	0	1	1	35,51,99,115	Internal error
0	X	1	X	0	1	0	1	37,53,101,117	Execution error warning
0	X	1	X	0	1	1	0	38,54,102,118	Internal error warning
				--	--	--	--		Four-bit status code
									Spectrum analyzer busy condition
									Abnormal (1) or normal (0) condition
									SRQ is asserted (depends on RQS and EOS commands)

INTERFACE MESSAGES

DCL (20) — Clears OPI/O buffer and status byte
 GET (8) — Aborts and then rearms sweep
 GTL (1) — Go to local control
 IFC (IFC line) — initializes talker and listener functions
 LLO (17) — lock lockout
 PPC (5) — Parallel poll configure
 PPU (21) — Parallel poll unconfigure
 SDC (4) — Same as DCL if listener addressed
 SPD (25) — Serial poll disable
 SPE (24) — Serial poll enable
 TCT (9) — Take control

- Form a query by adding a question mark to the header of a Display Data I/O, Marker, System, or Front-Panel header (AREs?) unless no query is indicated. POInt? is the only Waveform Processing query.
- The header will be returned with query responses with HDR ON, or the header will not be returned with HDR OFF.
- NUM is a decimal number; integer, floating point, or scientific notation.
- NUM may be substituted for ON or OFF; 1=ON, 0=OFF.
- NUM may be followed by units in engineering notation for frequency, time, and amplitude; 100 MHz, 10 μ s, -60 dBm.

NOTES

- To assure correct and expected results during signal processing, use the Single Sweep triggering mode while programming. The signal processing commands are HRAMPL, LRAMPL, MFBIG, MLFTNX, PKFIND, MMAX, MMIN, MRGTNX, MVLFDB, MVRTDB, CURVE, WAVFRM, DPRE, DCOPI, FIBIG, LFTNXT, RGTNXT, FMAX, and FMIN.
- Only the first three letters of a mnemonic are required (e.g., ARE for AREs); except, all of the letters of the units arguments for REFLVL and MAXPWR must be entered.

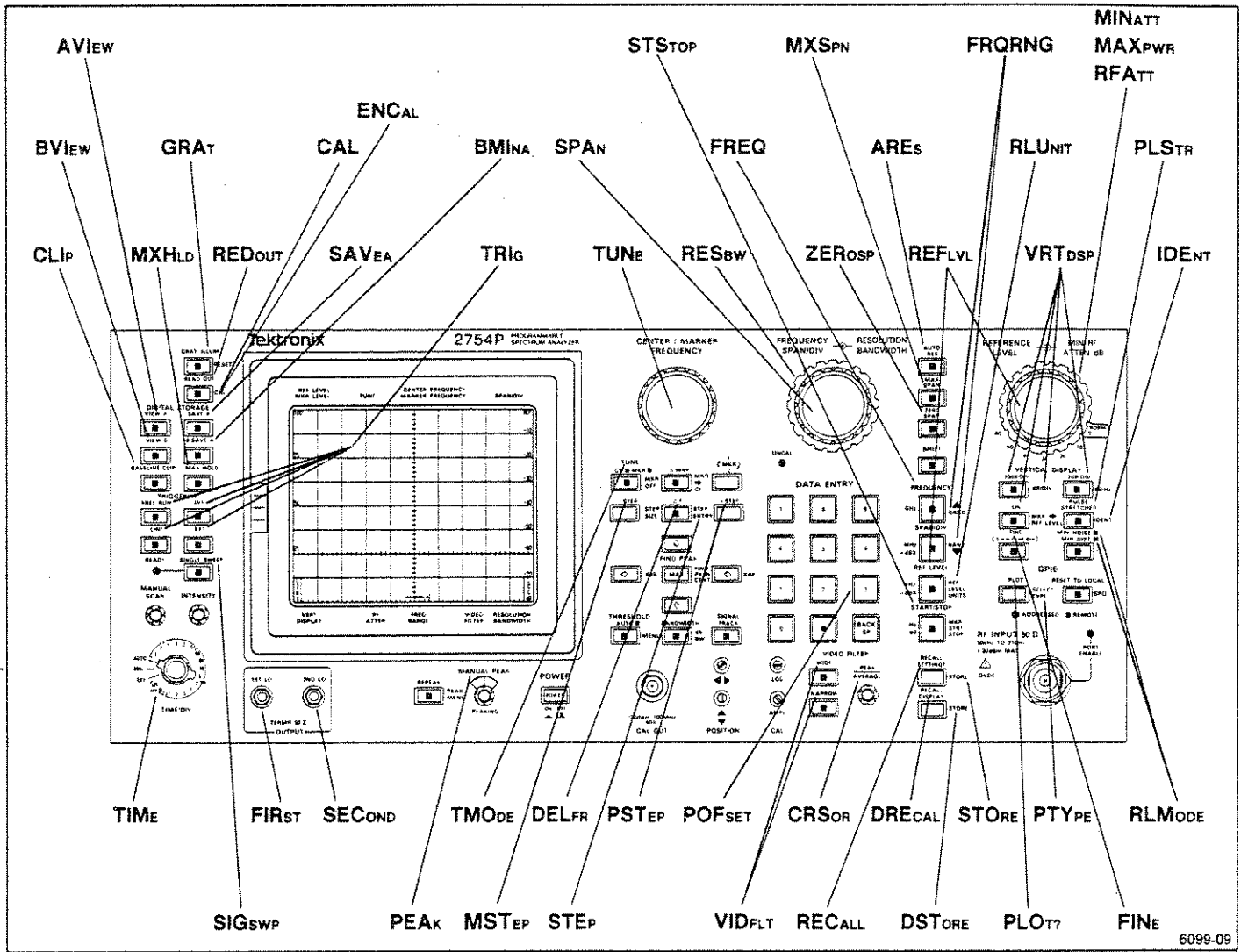

Figure B-1. TEKTRONIX 2754P Spectrum Analyzer

2754P COMMANDS AND QUERIES

2754P COMMANDS AND QUERIES (cont)

Header	Argument	Function	Header	Argument	Function
Front Panel (refer to Figure B-1)			Front Panel (cont)		
ARES	ON,OFF,NUM	Auto resolution bandwidth	SAVEA	ON,OFF,NUM	Save A
AVIEW	ON,OFF,NUM	View A	SECOND	NUM	2nd LO
BMINA	ON,OFF,NUM	B-Save A	SIGSWP		Single sweep
BVIEW	ON,OFF,NUM	View B	SPAN	NUM,INC,DEC,MAX	Frequency span/div
CAL	NUM,AUTO,LOG,AMPL,HPOS,VPOS	Calibrate IF filters	STEP	PRIMAR,SECOND DELTA,CF,NUM	Step size
CLIP	ON,OFF,NUM	Baseline clip	STORE	NUM	Store settings (no query)
CRSOR	KNOB,PEAK,AVG,NUM	Peak/Average cursor	STSTOP	MARKER,NUM	Start-stop sweep
DEGAUS		Degaus tuning coils (no query)	TIME	NUM,AUTO,INC,DEC,MAN,EXT	Time/division
DELFR	ON,OFF,NUM	ΔF	TMODE	FREQ,MARKER,NUM	Set tune mode
DISCOR	ON,OFF,NUM	Disable corrections	TRIG	FRERUN,INT,LINE,EXT,NUM	Triggering
DRECAL	A,B	Recall display	TUNE	NUM	Incremental frequency change (no query)
DSTORE	A,B	Store display (no query)	VIDFLT	OFF,WIDE,NARROW,NUM	Video filter
ENCAL	OFF,ON,ZERO,NUM	Enable calibration factors	VRTDSP	LOG:NUM,LIN:NUM,	Vertical display
FINE	ON,OFF,NUM	Fine reference level steps	ZEROSP	ON:OFF,NUM	Zero span
FIRST	NUM	1st LO	Marker System		
FRCAL	NUM	Center frequency calibrate	BWMODE	ON,OFF,IDLE	Marker bandwidth mode
FREQ	NUM	Center Frequency	BWNUM	NUM	Bandwidth number
FRQRNG	NUM,INC,DEC	Frequency range	DPMK		Display pointer to marker (no query)
GRAT	ON,OFF,NUM	Graticule illumination	HRAMPL		Next higher amplitude
HDR	ON,OFF,NUM	Header	LRAMPL		Next lower amplitude
IDENT	ON,OFF,NUM	Identify	MAMPL?	PRIMAR,SECOND,DELTA	Marker amplitude
IMPED	ON,OFF,NUM	Impedance (Option 07 only)	MARKER	OFF,ON,SINGLE,DELTA,NUM	Marker mode
MAXPWR	NUM,INC,DEC	Maximum input power	MCEN		Marker to center (no query)
MINATT	NUM,INC,DEC	Minimum RF attenuation dB	MCPOIN	ON,OFF,NUM	Marker coupled to display pointer
MSTEP		Minus step	MEXCHG		Marker exchange (no query)
MXHLD	ON,OFF,NUM	Maximum hold	MFBIG		Marker peak find
MXSPN	ON,OFF,NUM	Maximum span	MFREQ	PRIMAR	Marker frequency
PEAK	AUTO,NUM,INC,DEC,KNOB,STORED	Manual peak	MKDP		Marker to display pointer (no query)
PLOT?		Plot display	MLFTNX		Marker left next
PLSTR	ON,OFF,NUM	Pulse stretcher	MLOCAT?	PRIMAR,SECOND DELTA	Marker location
POFSET	NUM	Set K $\{(B-A)+K\}$	MMAX	NUM	Move marker to maximum
PSTEP		Plus step	MMIN	NUM	Move marker to minimum
PTYPE	TK4662,TKOP31,HP7470,MCOLOR,NUM	Set plotter type	MRGTNX		Marker right next
RECALL	NUM	Recall settings			
REDOUT	ON,OFF,NUM	Character readout			
REFLVL	NUM,INC,DEC	Reference level			
RESBW	NUM,AUTO,INC,DEC	Resolution bandwidth			
RFATT?		RF attenuation			
RLMODE	MNOISE,MDIST,NUM	Minimum noise/minimum distortion			
RLUNIT	DBM,DBV,DBMV,	Reference level units			

2754P COMMANDS AND QUERIES (cont)

Header	Argument	Function
Marker System (cont)		
MTOP		Marker to reference level (no query)
MTRACE	PRIMAR,SECOND	Marker trace position
MTUNE	HZ,KHZ,MHZ,GHZ	Tune marker
MVLFDB	+,-	Move marker left x dB
MVRTDB	+,-	Move marker right x dB
NSELVL	ON,OFF,NUM	Noise level normalization
SGERR	ON,OFF,NUM	Signal find error
PKFIND		Marker to maximum above threshold
SGTRAK	ON,IDLE,OFF,NUM	Signal track
STYPE	CW,PULSE,SPURS,NUM	Signal type
THRHL	AUTO,NUM	Marker threshold
ZOOM	NUM	Zoom (no query)

Display Data I/O

CURVE	CRVID and integers	Display curve I/O or block binary
DCOPY?		Copy display
DPRE?		Display preamble
_ORDO?		Lower crt readout
MDRDO?		Middle crt readout
RDOUT	Up to 40 characters	Crt readout message (no query)
TEXT	SHORT,LONG	Text
JPRDO?		Upper crt readout
NAVFRM?		Waveform
MFMPRE	WFID,EDCDG	Waveform preamble

Waveform Processing

CENSIG		Center signal (no query)
FIBIG	Threshold NUM	Find biggest signal (no query)
FMAX	NUM	Find maximum value (no query)
FMIN	NUM	Find minimum value (no query)
.FTNXT	Threshold NUM	Find left-next signal (no query)
POINT	X NUM,Y NUM	Display data point
IGTNXT	Threshold NUM	Find right-next signal (no query)
OPSIG		Change reference level to move signal to top of graticule (no query)

System Messages

.LLEV?		All events
IT	ON,OFF,NUM	Device trigger enable
.OS	ON,OFF,NUM	End-of-sweep SRQ control
.RCNT?		Error count
.RR?		Errors
.VENT?		Event information
.VQTY?		Event quantity

2754P COMMANDS AND QUERIES (cont)

Header	Argument	Function
System Messages (cont)		
ID?		Identify instrument
INIT		Initialize settings
NUMEV	NUM	Number of events
REPEAT	NUM	Repeat execution
RQS	ON,OFF,NUM	Turn on or off abnormal SRQ mask
SET?		Request instrument settings
STATUS BYTE		Response to serial poll
TEST?		Internal test
WAIT		Wait for end of sweep (no query)
WARMSG	ON,OFF	Warning message

COMMANDS AND QUERIES
PROGRAMMING SUMMARY

MANUAL CHANGE INFORMATION

At Tektronix, we continually strive to keep up with latest electronic developments by adding circuit and component improvements to our instruments as soon as they are developed and tested.

Sometimes, due to printing and shipping requirements, we can't get these changes immediately into printed manuals. Hence, your manual may contain new change information on following pages.

A single change may affect several sections. Since the change information sheets are carried in the manual until all changes are permanently entered, some duplication may occur. If no such change pages appear following this page, your manual is correct as printed.

The following commands are added to enhance instrument programming operation.

INSTRUMENT CONTROL

Frequency

TGMODE (tracking generator mode) command

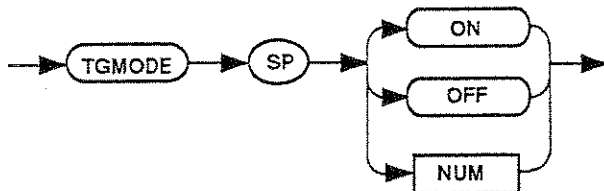

The TGMODE command allows higher frequency accuracy when using a tracking generator. When TGMODE is ON, the frequency correction factors for all resolution bandwidth filters wider than 10 kHz are disabled. These wide filters may be centered too far from 10 MHz for the difference to be corrected with the Tracking Adjust control on the tracking generator.

TGMODE will be returned with the SET? response.

ON — The tracking generator mode is turned on.

OFF — The tracking generator mode is turned off.

Power-up Value — OFF.

TGMODE (tracking generator mode) query



Response to TGMODE query

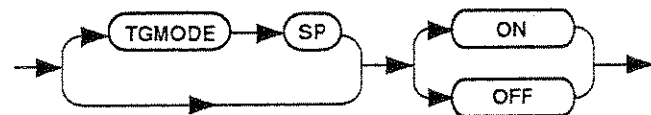

SAMODE (sideband analyzer mode) command

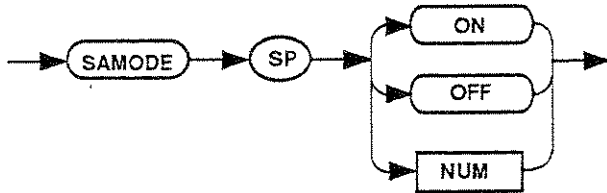

SAMODE is active in Band 1 only. When the SAMODE command is ON, the spectrum analyzer phase locks in 50 kHz/div instead of the normal 200 kHz/div. This extends the usefulness of the 1405 Sideband Analyzer, which uses only the first local oscillator of the spectrum analyzer.

SAMODE will be returned with the SET? response.

ON — The sideband analyzer mode is turned on.

OFF — The sideband analyzer mode is turned off.

Power-up Value — OFF.

SAMODE (sideband analyzer mode) query



Response to SAMODE query

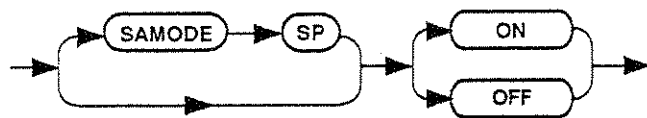

Vertical Display and Reference Level

RGMODE (reduced gain mode) command

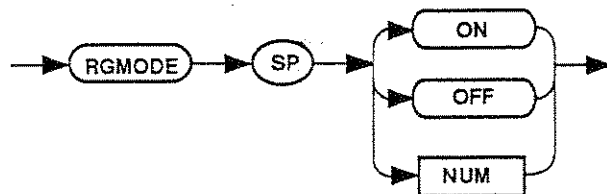

This command enables or disables 10 dB of IF gain and RF attenuation reduction when in 10 dB/division.

RGMODE will be returned with the SET? response.

ON — The reduced gain mode is turned on.

OFF — The reduced gain mode is turned off.

Interaction — When IDENT and RGMODE are ON, the identify trace moves up instead of down. RGMODE affects the maximum reference level you can get with the REFLVL command. When not in 10 dB/div vertical display, RGMODE does not affect the gain distribution.

Power-up value — OFF.

RGMODE (reduced gain mode) query



Response to RGMODE query

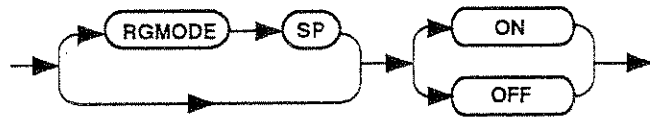

General Purpose

ECR (end of sweep corrections) command

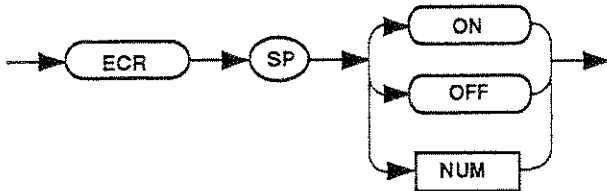

This command causes oscillator corrections to occur either at the end of every sweep or as needed, based on the drift rate of the oscillators.

ECR will be returned with the SET? response.

ON — Oscillator corrections occur at the end of every sweep.

OFF — The time between oscillator corrections is determined by the drift rate of the oscillators.

Interaction — When ECR is ON, corrections will generally occur more frequently than when ECR is OFF. The extra time spent correcting the oscillators may lengthen the response time to other commands and queries.

Power-up value — OFF

ECR query



Response to ECR query

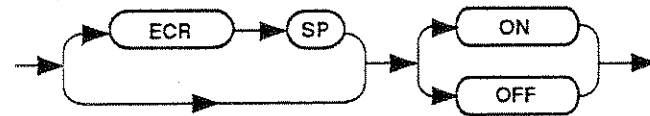

MARKER SYSTEM

Marker Positioning

MKTIME (marker time) command

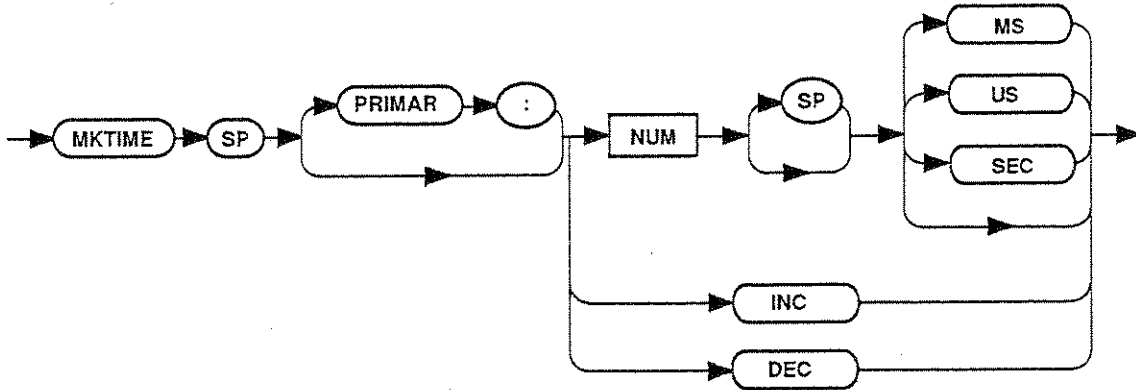

- The MKTIME command sets the time of the Primary marker with respect to the trigger point (1/2 division to the left of the screen) to the value given in NUM.

Examples — MKTIME 1MS
MKT .1 S

Power-up value — Markers are off when power is first turned on to the instrument. When markers are turned on in zero span, or the instrument is set to zero span with the markers on and ZETIME is set to ON, the markers are placed at center screen and the time value is set accordingly.

Interaction — MKTIME is available only when the instrument is in the zero span mode. If MKTIME is used when the instrument is not in the zero span mode or ZETIME is OFF, marker execution error message 107 is issued. An attempt to set a time that would be off either the left or right of the screen will cause marker execution error message 108 to be issued.

MKTIME (marker time) query

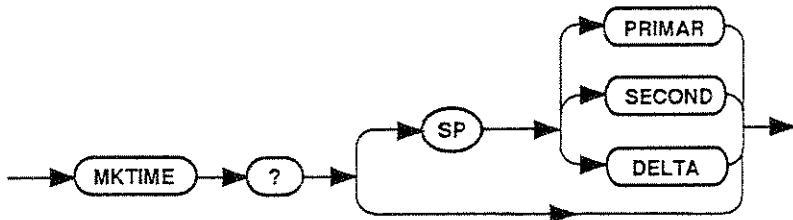

MKTIME? or MKTIME? PRIMAR — The time is returned for the Primary marker.

MKTIME? SECOND — The time is returned for the Secondary marker.

MKTIME? DELTA — The time is returned for the Primary marker with respect to the Secondary marker.

Interaction — The MKTIME query will return -200 if the time value is unavailable, +200 if the instrument is not in the zero span mode or ZETIME is OFF, and +999.99 if the marker system is off (or MARKER is not set to DELTA when the secondary or delta time is requested).

Response to MKTIME query

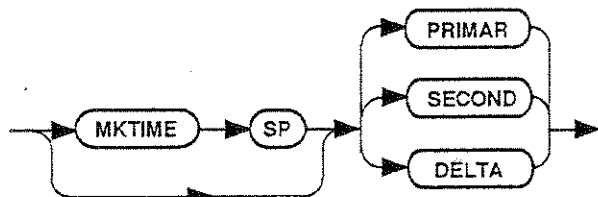

Marker Finding

PKCEN (marker to maximum and center) command

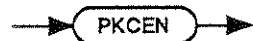

The PKCEN command is a combination of the PKFIND and MCEN commands. The Primary marker is moved to the largest left-most vertical value in digital storage if that value is above the threshold, and is then tuned to center screen. For additional information, refer to the descriptions of PKFIND and MCEN earlier in this section.

Interaction — PKCEN is not available in ZEROSP or MXSPN.

There is no PKCEN query.

Miscellaneous

ZETIME (zero span) command

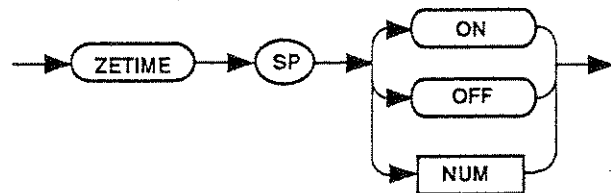

ZETIME will be returned with the SET? response.

ON — In zero span, the marker readout is amplitude and time.

OFF — In zero span, the marker readout is amplitude and frequency.

Power-up value — OFF.

Interaction — The ZETIME command has no effect when the instrument is in a non-zero span. If the markers are on different traces, the Secondary marker will move to the Primary marker trace under either of the following conditions. Under the same conditions, if the Secondary marker is off-screen, it will move on-screen.

- If the ZETIME ON command is given with the Primary marker on a zero-span trace.
- If the Primary marker is moved to a zero-span trace while ZETIME is ON.

ZETIME (zero span) query



Response to ZETIME query

